

PMSA

Micro ATX Motherboard

User's Manual

Edition 1.01

2008/05/06



Copyright

Copyright 2007, all rights reserved. This document is copyrighted and all rights are reserved. The information in this document is subject to change without prior notice to make improvements to the products.

This document contains proprietary information and protected by copyright. No part of this document may be reproduced, copied, or translated in any form or any means without prior written permission of the manufacturer.

All trademarks and/or registered trademarks contains in this document are property of their respective owners.

Disclaimer

The company shall not be liable for any incidental or consequential damages resulting from the performance or use of this product.

The company does not issue a warranty of any kind, express or implied, including without limitation implied warranties of merchantability or fitness for a particular purpose. The company has the right to revise the manual or include changes in the specifications of the product described within it at any time without notice and without obligation to notify any person of such revision or changes.

Trademark

All trademarks are the property of their respective holders.

Any questions please visit our website at <http://www.commell.com.tw>

Packing List:

Please check the package content before you starting using the board.

Hardware:

PMSA Micro ATX Motherboard x 1

Cable Kit:



40-pin ATA100 IDE Cable x 1

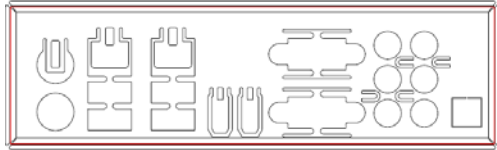

I/O Shield x 1



Floppy Cable x 1

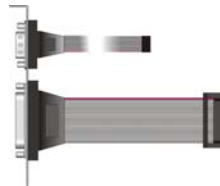

COM x 1 & printer x 1



SATA Cable x 2



CPU Cooler x 1

Printed Matters:

Driver CD x 1 (including User's Manual)

Index

Chapter 1 <Introduction> 6

 1.1 <Product Overview>.....6

 1.2 <Product Specification>7

 1.3 <Mechanical Drawing>9

 1.4 <Block Diagram> 10

Chapter 2 <Hardware Setup>..... 12

 2.1 <Connector Location> 12

 2.2 <Jumper Location & Reference>..... 13

 2.3 <Connector Reference> 15

 2.3.1 <Internal Connectors>.....15

 2.3.2 <External Connectors>.....15

 2.4 <CPU and Memory Setup> 16

 2.4.1 <CPU Setup>16

 2.4.2 <Memory Setup>17

 2.5 <CMOS Setup> 18

 2.6 <Enhanced IDE Interface> 19

 2.7 <Serial ATA Interface> 20

 2.8 <Floppy Port>..... 21

 2.9 <Ethernet Interface> 22

 2.10 <Onboard Display Interface> 23

 2.10.1 <Analog Display>23

 2.10.2 <Digital Display>.....24

 2.10.3 <HDTV Interface>28

 2.11 <Integrated Audio Interface>..... 29

 2.12 <GPIO Interface> 31

 2.13 <Power Supply> 32

 2.13.1 <Power Connector>.....32

 2.14 <Switch and Indicator>.....34

Chapter 3 <System Setup>	35
3.1 <Audio Configuration>	35
4. Select the sound mode to meet your speaker system.	35
3.2 <Video Memory Setup>	36
3.3 <Display Properties Setting>.....	38
Chapter 4 <BIOS Setup>	40
Appendix A <I/O Port Pin Assignment>	42
A.1 <IDE Port>	42
A.2 <Serial ATA Port>.....	43
A.3 <Floppy Port>.....	43
A.4 <IrDA Port>.....	43
A.5 <Serial Port 1>.....	44
A.6 <Serial Port 2>.....	44
A.7 <Serial Port 3/4/5/6>	44
A.8 <Parallel Port>.....	45
A.9 <VGA Port>.....	45
A.10 <LAN Port>.....	45
A.11 < USB Interface >.....	46
Appendix B <Flash BIOS>	47
B.1 <Flash Tool>	47
B.2 <Flash BIOS Procedure>.....	47
Appendix C <System Resources>	48
Appendix D <Programming GPIO's>	53
Appendix E <Programming Watchdog Timer >	54
Appendix F <How to setting RS-422,RS-485 & IrDA>	55
Contact Information	56

(This page is left for blank)

Chapter 1 <Introduction>

1.1 <Product Overview>

PMSA is the new generation of the Micro ATX motherboard, with supporting Intel Core 2 Duo **socket-P** processors for 533/800MHz front side bus, Intel GM(E)965 and ICH8M chipset, integrated GMA X3100 graphics, DDR2 memory, REALTEK High Definition Audio, Serial ATA and two Intel Gigabit LAN.

Intel Merom dual core Processor

The board supports Intel Core 2 Duo **socket-P** processors with 533/800MHz front side bus, 4MB L2 cache, to provide more powerful performance than before.

New features for Intel GM(E)965 chipset

The board integrates Intel GM(E)965 and ICH8M chipset, to provide new generation of the mobile solution, supports Intel GMA X3100 graphics, DDR2 533/667Mhz memory, built-in high speed mass storage interface of serial ATA, High Definition Audio with 7.1 channels surrounding sound.

All in One multimedia solution

Based on Intel GM(E)965 and ICH8M chipset, the board provides high performance onboard graphics, 18/24-bit Single/dual channel LVDS interface, HDTV and 7.1 channels High Definition Audio, to meet the very requirement of the multimedia application.

Flexible Extension Interface

The board provides one PCI-Express x16 slots for graphics card, it also can support PCI-Express x1 for RAID card or other devices. The board also provides Compact Flash Type II slot and one mini-PCI socket.

1.2 <Product Specification>

General Specification

Form Factor	Micro ATX Industrial motherboard
CPU	Support Intel Core 2 Duo Mobile Processor Package type: Micro-FCPGA478 (Socket-P) Front side bus: 533/800 MHz
Memory	Two DDRII 533/667MHz DIMM up to 3GB with dual channel Interleaved mode
Chipset	Intel GM(E)965 & ICH8M (82801HBM)
Real Time Clock	Chipset integrated RTC with onboard lithium battery
Watchdog Timer	Generates a system reset with internal timer for 1min/s ~ 255min/s
Power Management	ACPI 1.0 compliant, supports power saving mode
PCI Enhanced IDE	One 40-pin UltraATA100/33 IDE interface supports up to 2 ATAPI devices
Serial ATA Interface	3 x serial ATAI interface with 300MB/s transfer rate
VGA Interface	Intel integrated extreme GMA X3100 (Graphic Media Accelerator) Technology
Video Memory	Up to 384MB shared with system memory
LVDS interface	Onboard 24-bit dual channel LVDS connector with +3.3V/+5V/+12V Supply
Audio Interface	Intel integrated ICH8M with Realtek ALC888 HD Audio
LAN Interface	Two Intel 82573L Gigabit LAN
Solid State Disk	One Compact Flash Type II
GPIO interface	Onboard programmable 8-bit Digital I/O interface
Extended Interface	1x PCIE x16 slot, 1 x PCIE x1 slot, 1 x Mini-PCI socket 2 x PCI and 1 x ISA slot
Internal I/O Port	1 X RS232/422/485 x4 RS232, 1x FDD port, 1x GPIO port, 1 x Parallel Port , 6 x USB ports, 1x IrDA, 1x HDTV 1x IDE, 1x LVDS, 1x LCD inverter connector, 1x HDTV, 1x Front panel Audio connector and 1 x CDIN connector
External I/O Port	1x PS/2 Keyboard/Mouse Port, 2 x RJ45 LAN ports, 1x DB15 VGA port, 4x USB2.0 ports, 2x IEEE 1394 port, 1 x COM port, 7.1 Channel Audio Output and 1x SPDIF connector
Power Requirement	Standard 24-pin ATX power supply (20-pin is compatible)
Dimension	244mm x 244mm
Temperature	Operating within 0~60 centigrade Storage within -20~85 centigrade

Ordering Code

PMSA	Onboard CRT, LVDS, HDTV, Intel Gigabit LAN, USB2.0, PCI, Mini-PCI, GPIO Port, 1394, IrDA, FDD, Parallel Port, COM Port, SATA, HD Audio and ISA slot
------	---

For further product information please visit the website at <http://www.comnell.com.tw>

1.3 <Mechanical Drawing>

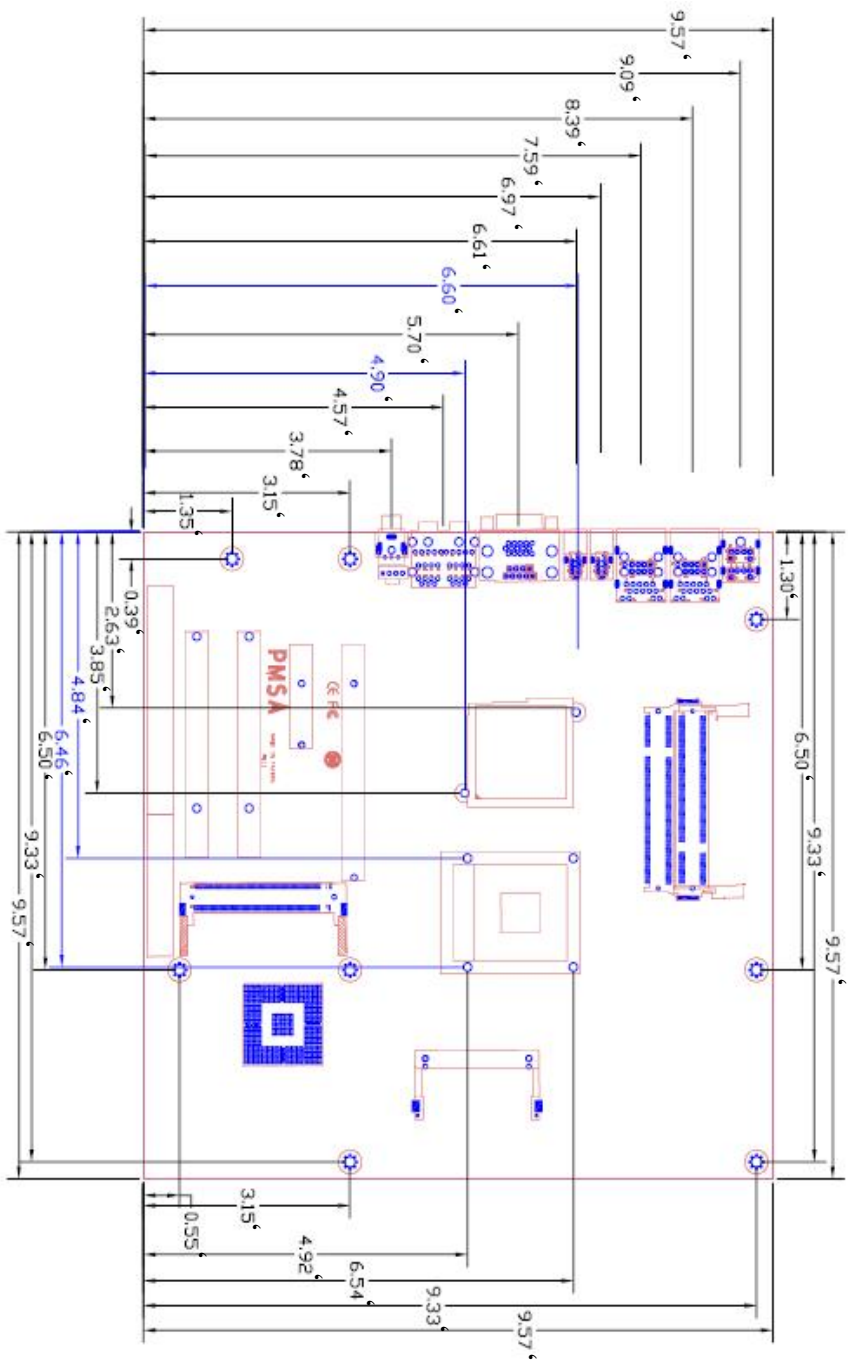

1.4 <Block Diagram>

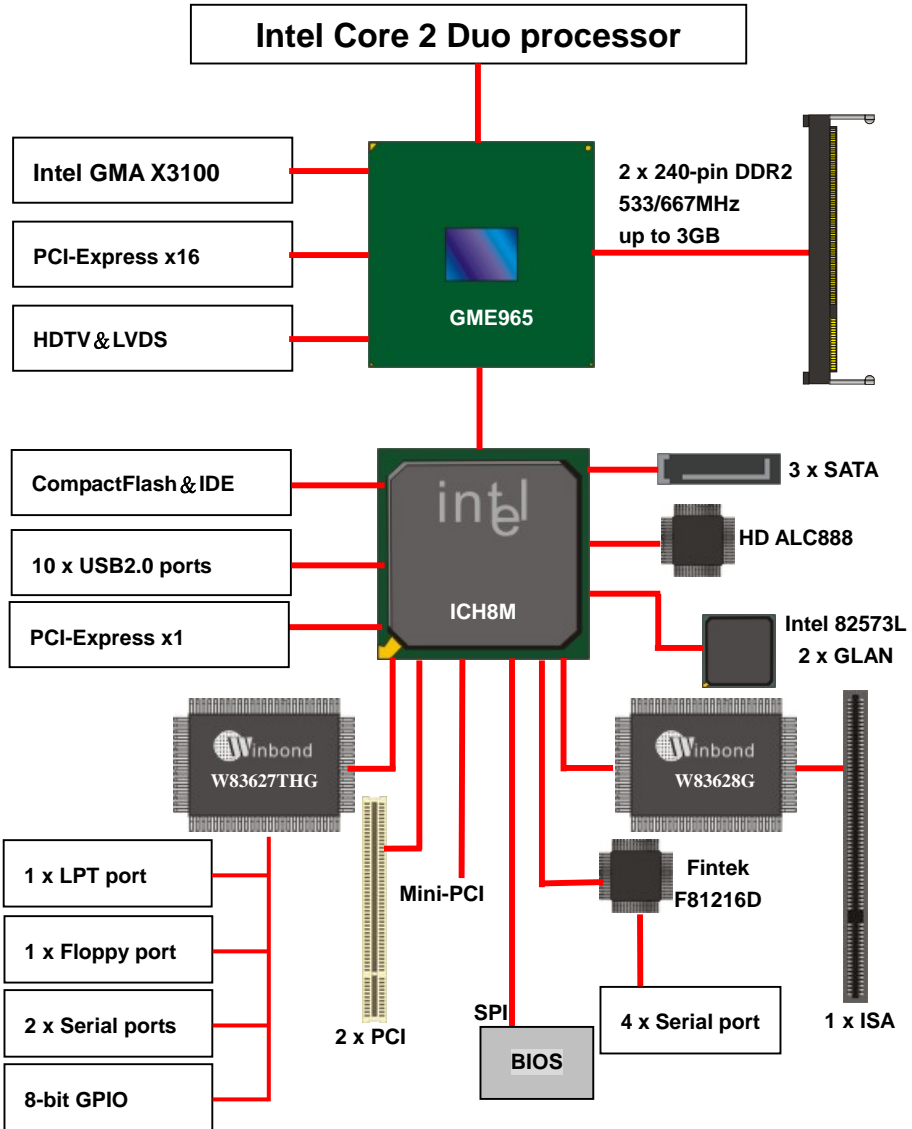

(This page is left for blank)

Chapter 2 <Hardware Setup>

2.1 <Connector Location>

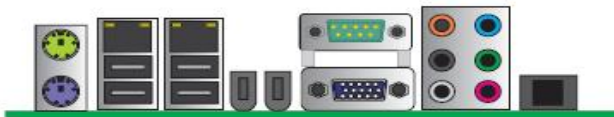
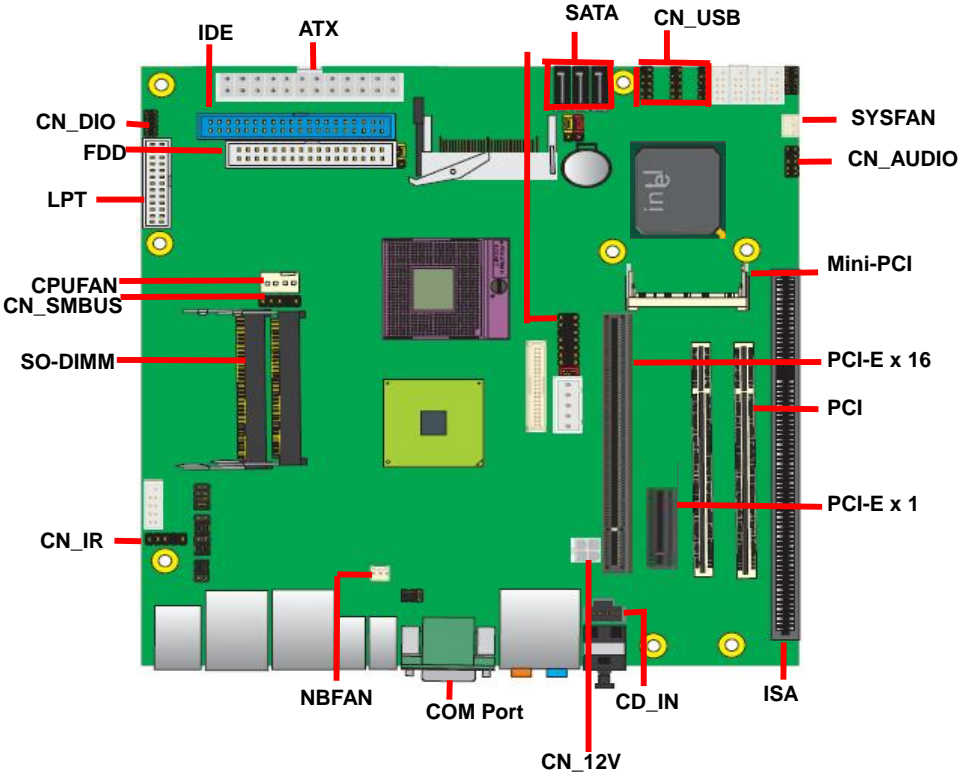

PS/2 USB&LAN 1394 CRT&COM1 Audio SPDIF

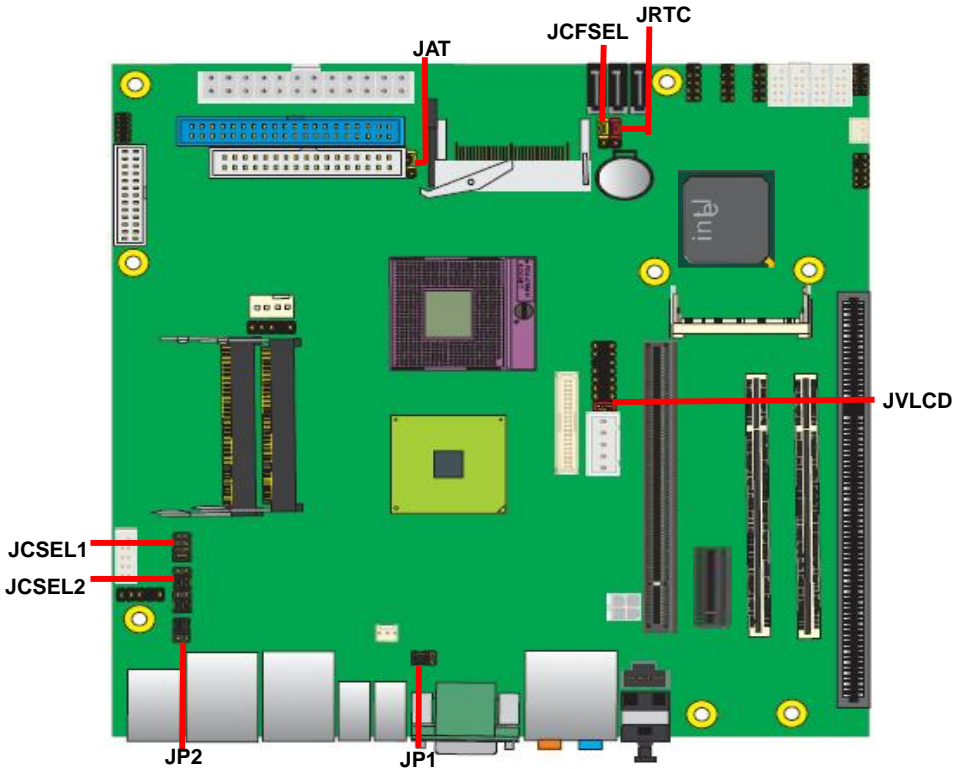

2.2 <Jumper Location & Reference>

Jumper	Function
JRTC	CMOS Operating/Clear Setting
JCFSEL	CF mode selection
JVLCD	Panel Voltage Setting
JP1	COM1 signal mode switch (For Pin-1 & Pin-9)
JP2	COM2 signal mode switch (For Pin-1 & Pin-9)
JAT	Power mode select





Jumper: **JAT**

Type: onboard 3-pin header

Power Mode	JAT
AT Mode	
ATX Mode	
Default setting: ATX Mode	
	



Jumper: **JP1 (COM 1)**

Type: onboard 3 x 2-pin header

Power Mode	JP1
Pin1 with 5V signal	
Pin9 with 12V signal	
Default setting: 3-5, 4-6	
	

Jumper: **JP2 (COM 2)**

Type: onboard 3 x 2-pin header

Power Mode	JP2
Pin1 with 5V signal	
Pin9 with 12V signal	
Default setting: 3-5, 4-6	
	

2.3 <Connector Reference>

2.3.1 <Internal Connectors>

Connector	Function	Remark
CPU	Socket478 for socket-P CPU	
SO-DIMM 1/2	2 x 200 -pin DDR2 SO-DIMM slot	
IDE	40-pin IDE connector	
FDD	34-pin floppy connector	
LPT	26-pin LPT port connector	
S_ATA1/2/3	7-pin Serial ATA connector	
ATX	24-pin power input connector	
CN_12V	4-pin +12V additional power supply connector	
CN_AUDIO	5 x 2-pin audio connector	
CDIN	4-pin CD-ROM audio input connector	
CN_DIO	6 x 2-pin digital I/O connector	
CN_USB	3 x 5 x 2-pin USB connector	
CPUFAN	4-pin CPU cooler fan connector	
SYSFAN	3-pin system cooler fan connector	
NBFAN	3-pin system cooler fan connector	
CN_HDTV	5 x 2-pin HDTV interface	
CN_LVDS	20 x 2-pin LVDS connector	
CN_INV	5-pin LCD inverter connector	
CN_IR	5-pin IrDA connector	
JFRNT	14-pin front panel switch/indicator connector	
Mini-PCI	1 x Mini-PCI socket Type IIIA	
PCI	2 x 32bit PCI slot	
CF	Compact Flash Type II socket	
COM2/3/4/5/6	Serial port connector	
PCIE_x16	PCI-Express x16 slot	
PCIE_x1	PCI-Express x1 slot	
ISA	16-bit/8-bit ISA slot	

2.3.2 <External Connectors>

Connector	Function	Remark
USB_RJ45	Dual USB and one RJ45 LAN connector	
CRT + COM1	DB15 analog VGA connector and COM1 Connect	
KB	PS/2 keyboard connector	
MS	PS/2 mouse connector	
AUDIO	Audio connectors	
1394	2 x IEEE1394 port	
SPDIF	SPDIF digital audio output connector	

2.4 <CPU and Memory Setup>

2.4.1 <CPU Setup>

The board comes with the socket478 for Intel Core 2 Duo **socket-P** processor only it supports new generation of Intel Core 2 Duo **socket-P** processor with 533/800MHz of front side bus and 4MB L2 cache. Please follow the instruction to install the CPU properly.

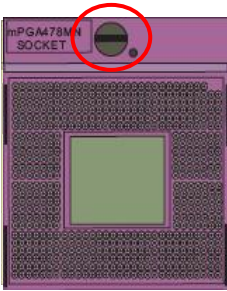

1. Use the flat-type screw drive to unlock the CPU socket

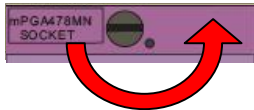

Unlock way

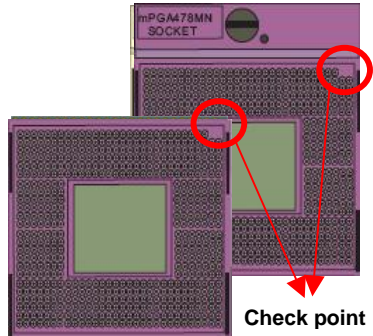

Check point

2. Follow the pin direction to install the processor on the socket

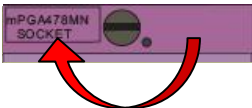

3. Lock the socket

4. Socket P has 478 pins, but is not pin-compatible with Socket M CPU.

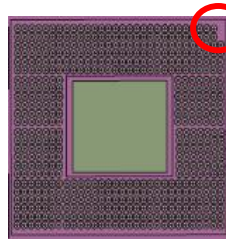

Socket-M CPU
Check point

2.4.2 <Memory Setup>

The board provides two 200-pin DDR2 SO-DIMMs to support 533/667MHz DDR2 memory modules up to 3GB of capacity. Non-ECC, unbuffered memory is supported only. While applying two same modules, dual channel technology is enabled automatically for higher performance.

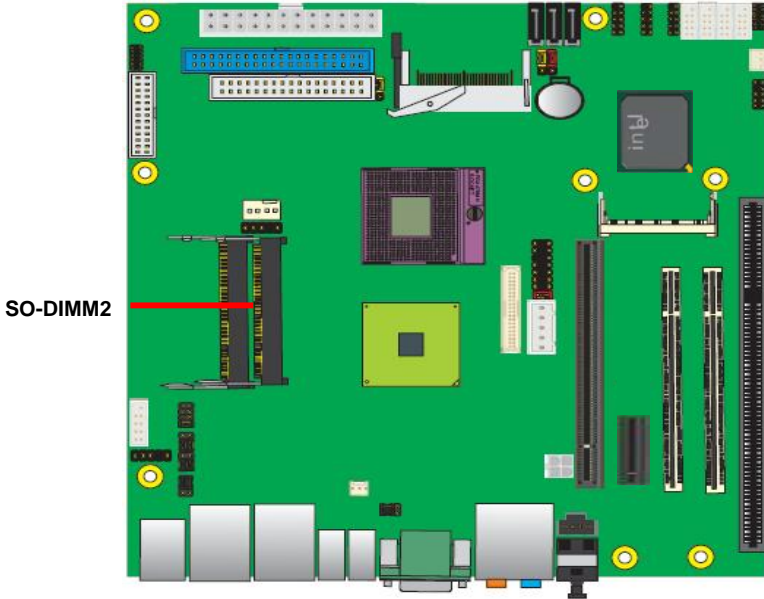

2.5 <CMOS Setup>

The board's data of CMOS can be setting in BIOS. If the board refuses to boot due to inappropriate CMOS settings, here is how to proceed to clear (reset) the CMOS to its default values.

Jumper: JRTC

Type: Onboard 3-pin jumper

JRTC	Mode
1-2	Clear CMOS
2-3	Normal Operation

Default setting: 2-3

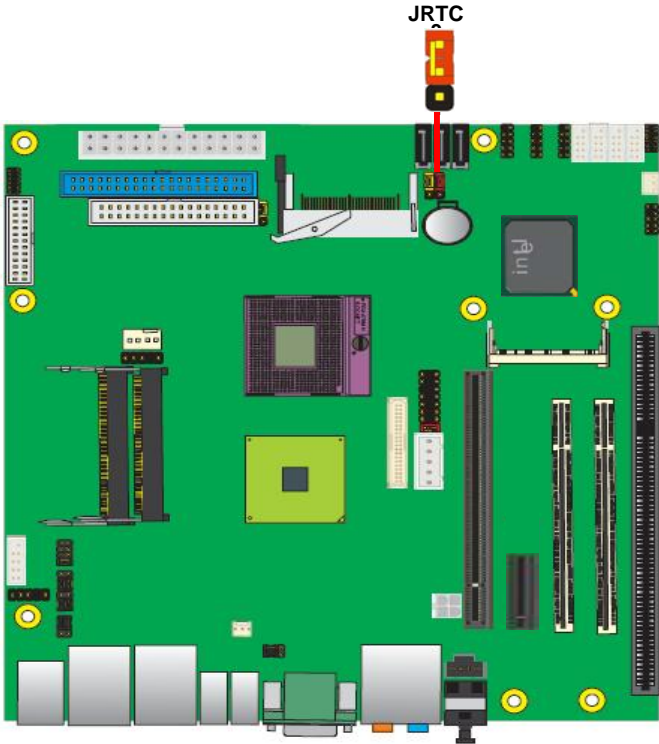

2.6 <Enhanced IDE Interface>

The board has one UltraDMA100/33 IDE interface to support up to 2 ATAPI devices, or one ATAPI device and Compact Flash Type II socket on the solder side, with jumper **JCFSEL** for IDE master/slave mode selection.

Jumper: **JCFSEL**

Type: onboard 3-pin header

JCFSEL	Mode
1-2	Master
2-3	Slave

Default setting: 2-3

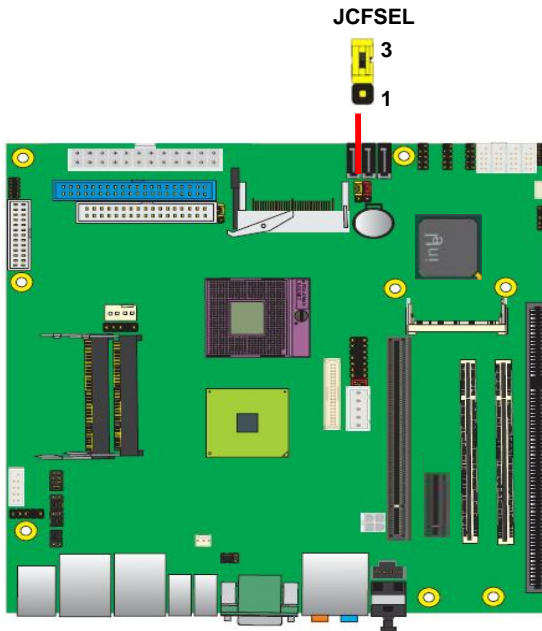

2.7 <Serial ATA Interface>

Based on Intel ICH8M, the board provides Three Serial ATAII interfaces with up to 300MB/s of transfer rate.

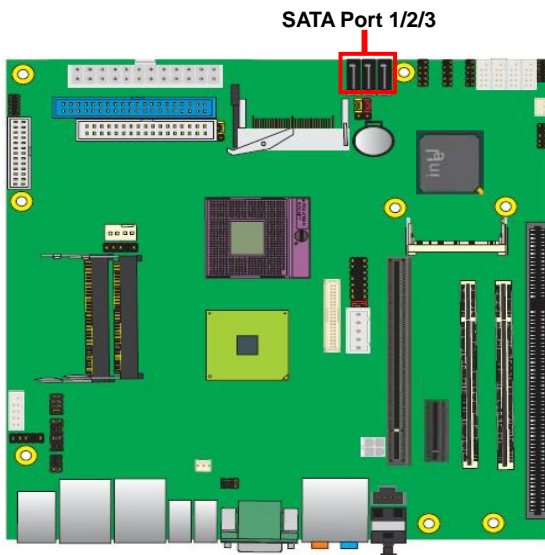

2.8 <Floppy Port>

The board provides one floppy port.

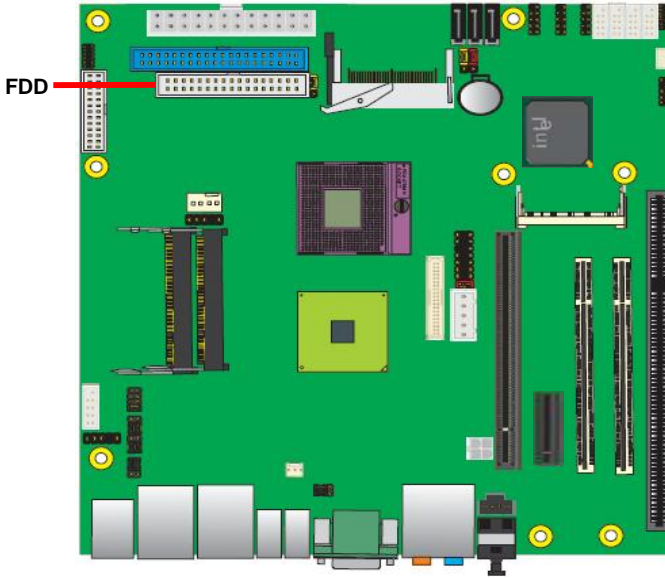

2.9 <Ethernet Interface>

The board integrates with two Intel PCI-Express Gigabit Ethernet controllers, as the PCI-Express 1x can speed up to 250MB/s of transfer rate instead of late PCI bus with 133MB/s of transfer rate. The Intel Gigabit Ethernet supports triple speed of 10/100/1000Base-T, with IEEE802.3 compliance and Wake-On-LAN supported.

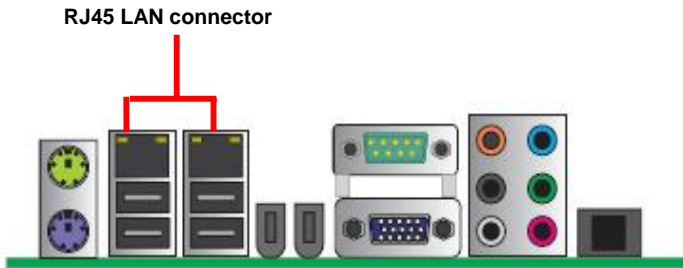

2.10 <Onboard Display Interface>

Based on Intel GM(E)965 chipset with built-in GMA (Graphic Media Accelerator) X3100 graphics, the board provides one DB15 connector on rear external I/O port, and one 40-pin LVDS interface with 5-pin LCD backlight inverter connector. The board provides dual display function with clone mode and extended desktop mode for CRT, LCD, and TV-out.

2.10.1 <Analog Display>

Please connect your CRT or LCD monitor with DB15 male connector to the onboard DB15 female connector on rear I/O port.



CRT

2.10.2 <Digital Display>

The board provides one 40-pin LVDS connector for 18/24-bit single/dual channel panels, supports up to 1600 x 1200 (UXGA) resolution, with one LCD backlight inverter connector and one jumper for panel voltage setting.

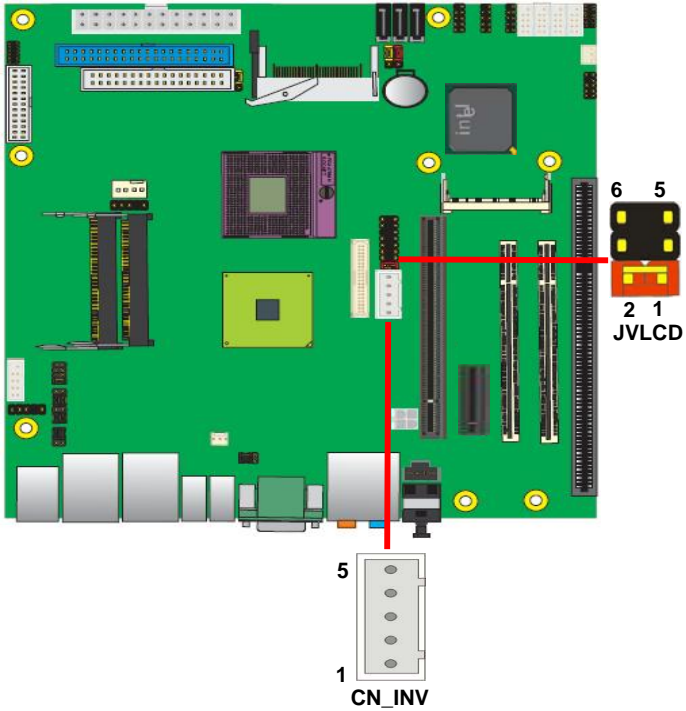

Attention: Don't short JVLCD odd to odd pin. It could be cause serious damage.

Connector: **CN_INV**

Type: 5-pin LVDS Power Header

Pin	Description
1	+12V
2	ENABKL
3	GND
4	GND
5	+5V

Connector: **JVLCD**

Type: 6-pin Power select Header

Pin	Description
1-2	LCDVCC (3.3V)
3-4	LCDVCC (5V)
5-6	LCDVCC (12V)

Connector: **CN_LVDS**

Type: onboard 40-pin connector for LVDS connector

Connector model: **HIROSE DF13-40DP-1.25V**

Pin	Signal	Pin	Signal
2	LCDVCC	1	LCDVCC
4	GND	3	GND
6	ATX0-	5	BTX0-
8	ATX0+	7	BTX0+
10	GND	9	GND
12	ATX1-	11	BTX1-
14	ATX1+	13	BTX1+
16	GND	15	GND
18	ATX2-	17	BTX2-
20	ATX2+	19	BTX2+
22	GND	21	GND
24	ACLK-	23	BTX3-
26	ACLK+	25	BTX3+
28	GND	27	GND
30	ATX3-	29	BCLK-
32	ATX3+	31	BCLK+
34	GND	33	GND
36	DDCPCLK	35	N/C
38	DDCPDATA	37	N/C
40	N/C	39	N/C

PMSA User's Manual

To setup the LCD, you need the component below:

1. A panel with LVDS interfaces.
2. An inverter for panel's backlight power.
3. A LCD cable and an inverter cable.

For the cables, please follow the pin assignment of the connector to make a cable, because every panel has its own pin assignment, so we do not provide a standard cable; please find a local cable manufacture to make cables.

LCD Installation Guide:

1. Preparing the **PMSA, LCD panel** and the **backlight inverter**.

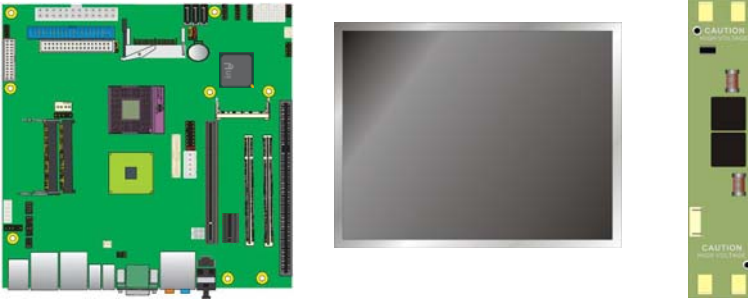

2. Please check the datasheet of the panel to see the voltage of the panel, and set the jumper **JVLCD** to +12V or +5V or +3.3V.
3. You would need a LVDS type cable.

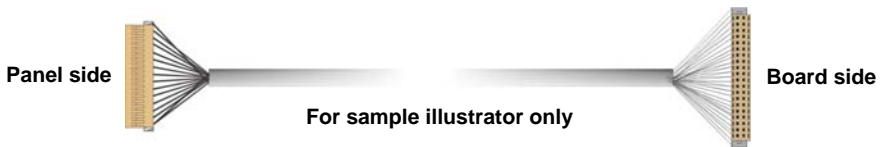

4. To connect all of the devices well.

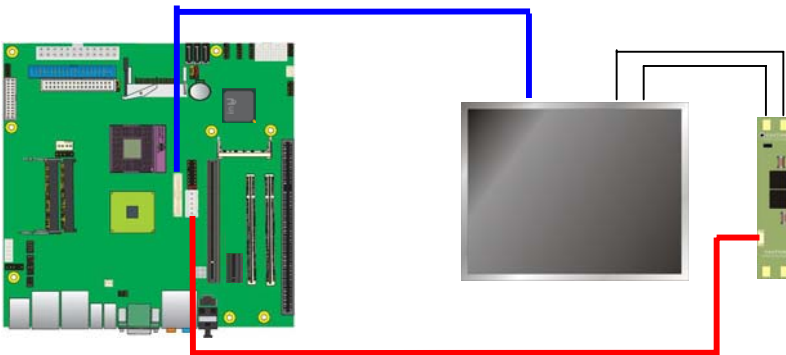

After setup the devices well, you need to select the LCD panel type in the BIOS.

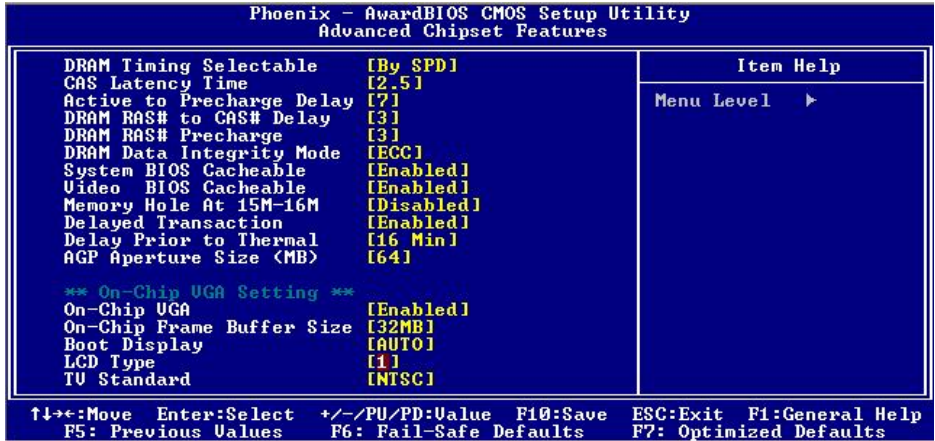

The panel type mapping is list below:

BIOS panel type selection form (BIOS Version:1.0)			
18-bit Single channel		24-bit Dual channel	
NO.	Output format	NO.	Output format
1	800 x 480	10	1024 x 768
2	800 x 600	11	1280 x 768
3	1024 x 768	12	1280 x 1024
24-bit Single channel		13	1366 x 768
4	1024 x 768	14	1400 x 1050 @ 108Mhz
5	1280 x 768	15	1600 x 1200
6	1280 x 800		
7	1280 x 1024		
8	1366 x 768		
9	1600 x 1200		

2.10.3 <HDTV Interface>

The board provides an HDTV interface with Intel GM(E) 965, supports Composite, S-Video and Component with PAL and NTSC of TV system, and display (clone or extended desktop) function with CRT,LVDS,DVI.

Connector: **CN_HDTV**

Connector type: 10-pin header HDTV connector (pitch = 2.54mm)

Pin Number	Assignment	Pin Number	Assignment
1	GND	2	DACB1
3	DACB2	4	GND
5	GND	6	N/C
7	DACB3	8	GND
9	N/C	10	N/C

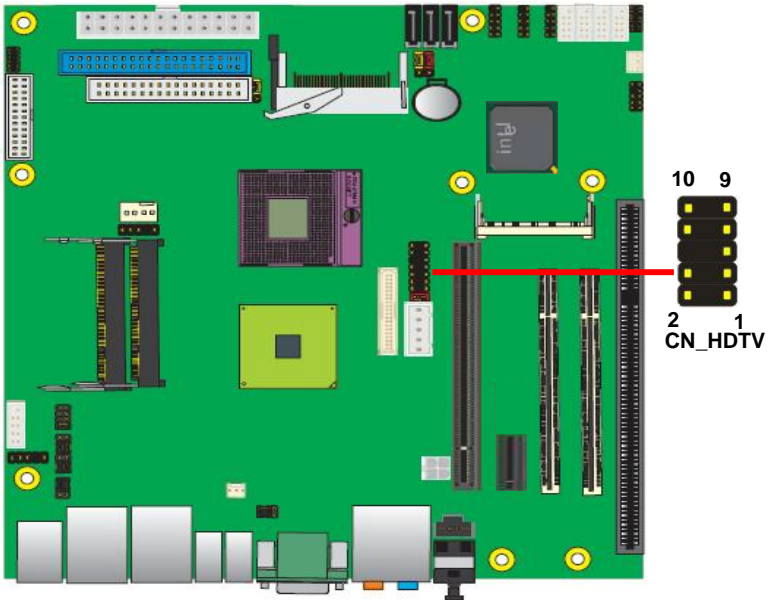

2.11 <Integrated Audio Interface>

The board integrates onboard audio interface with REALTEK ALC888 codec, with Intel next generation of audio standard as High Definition Audio.

The main specifications of ALC888 are:

- **High-performance DACs with 100dB S/N ratio**
- **8 DAC channels support 16/20/24-bit PCM format for 5.1 audio solution**
- **16/20/24-bit S/PDIF-OUT supports 44.1K/48K/96kHz sample rate**
- **Meets Microsoft WHQL/WLP 2.0 audio requirements**

The board provides 5.1 channels audio phone jacks on rear I/O port, Line-in/MIC-in ports for front I/O panel through optional cable.

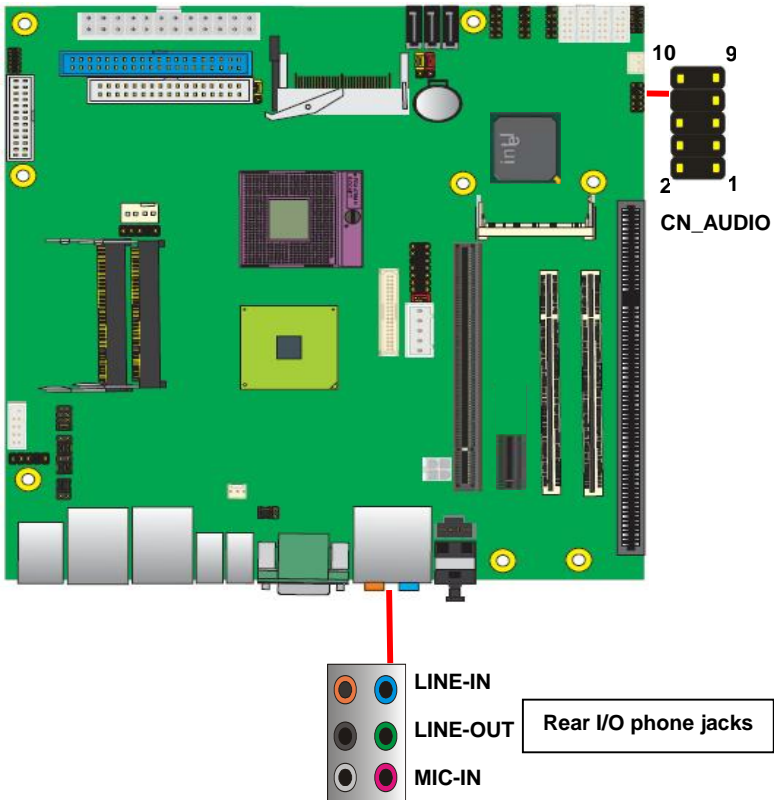

Connector: CN_AUDIO

Type: 10-pin (2 x 5) 1.27mm x 2.54mm-pitch header

Pin	Description	Pin	Description
1	MIC_L	2	Ground
3	MIC_R	4	Reserve
5	Speaker_R	6	MIC Detect
7	SENSE	8	N/C
9	Speaker_L	10	Speaker Detect

Connector: CDIN

Type: 4-pin header (pitch = 2.54mm)

Pin	Description
1	CD – Left
2	Ground
3	Ground
4	CD – Right

2.12 <GPIO Interface>

The board provides a programmable 8-bit digital I/O interface; you can use this general purpose I/O port for system control like POS or KIOSK.

Connector: **CN_DIO**

Type: 12-pin (6 x 2) 1.27mm x 2.54mm-pitch header

Pin	Description	Pin	Description
1	Ground	2	Ground
3	GP10	4	GP14
5	GP11	6	GP15
7	GP12	8	GP16
9	GP13	10	GP17
11	VCC	12	+12V

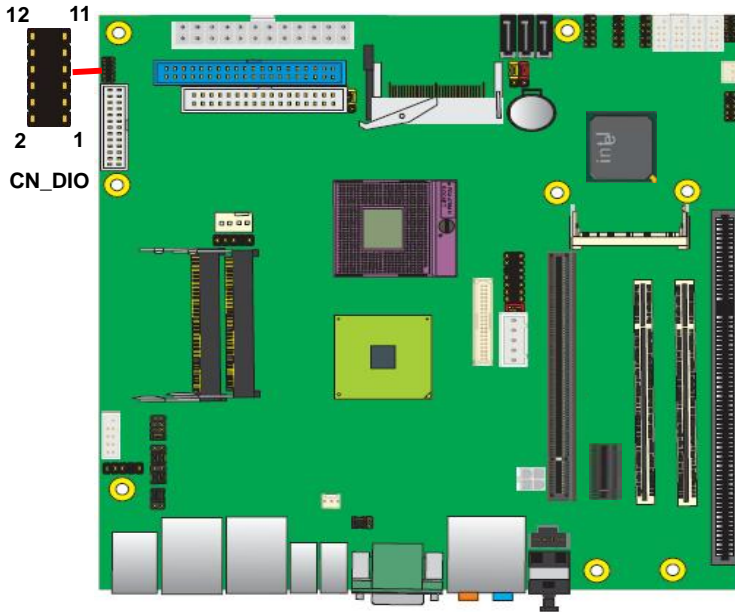

2.13 <Power Supply>

The PMSA provides a standard ATX power supply with 24-pin ATX connector , and the board provides one 4-pin fan connector supporting smart fan for CPU cooler and one 3-pin cooler fan connector for system .

2.13.1 <Power Connector>

Connector: ATX

Type: 24-pin ATX power connector

PIN assignment			
1	3.3V	13	3.3V
2	3.3V	14	-12V
3	GND	15	GND
4	5V	16	PS_ON
5	GND	17	GND
6	5V	18	GND
7	GND	19	GND
8	PW_OK	20	-5V
9	5V_SB	21	5V
10	12V	22	5V
11	12V	23	5V
12	3.3V	24	GND

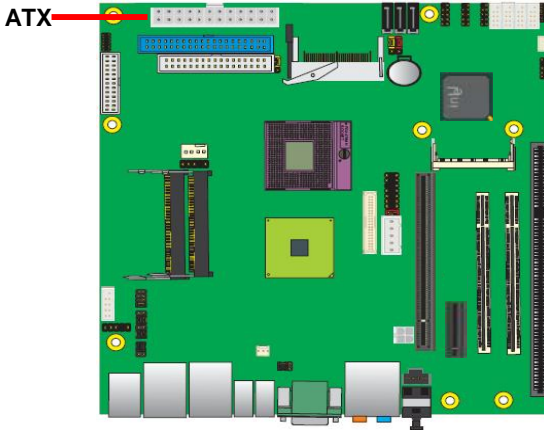

2.13.2 <Fan Connector>

Connector: **SYSFAN**

Type: 3-pin fan wafer connector

Pin	Description	Pin	Description	Pin	Description
1	Ground	2	+12V	3	Fan Control

Connector: **CPUFAN**

Type: 4-pin fan wafer connector

Pin	Description	Pin	Description
1	Ground	2	+12V
3	Fan Speed Detection	4	Sense

Connector: **NBFAN**

Type: 3-pin fan wafer connector

Pin	Description	Pin	Description	Pin	Description
1	Ground	2	+12V	3	Fan Control

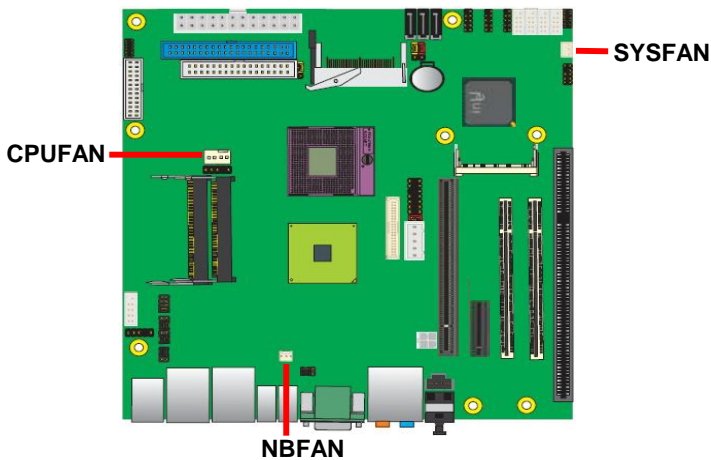

2.14 <Switch and Indicator>

The **JFRNT** provides front control panel of the board, such as power button, reset and beeper, etc. Please check well before you connecting the cables on the chassis.

Connector: **JFRNT**

Type: onboard 14-pin (2 x 7) 2.54-pitch header

Function	Signal	PIN		Signal	Function
IDE LED	HDLED+	1	2	PWRLED+	Power LED
	HDLED-	3	4	N/C	
Reset	Reset+	5	6	PWRLED-	Speaker
	Reset-	7	8	SPK+	
N/C		9	10	N/C	
Power Button	PWRBT+	11	12	N/C	
	PWRBT-	13	14	SPK-	

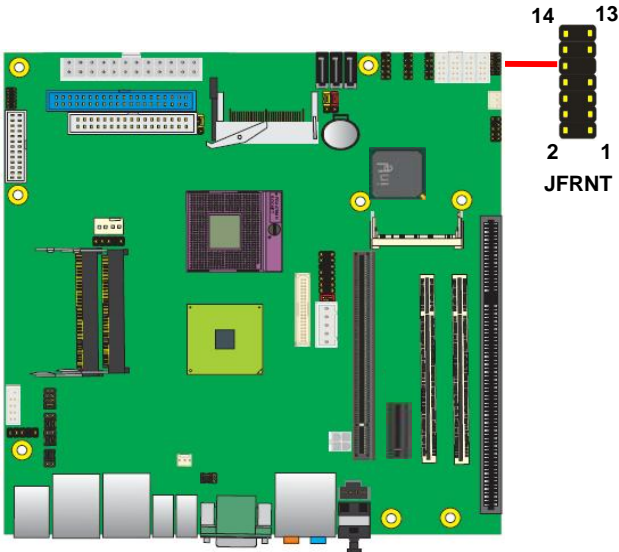

Chapter 3 <System Setup>

3.1 <Audio Configuration>

The board integrates Intel® ICH8DO with REALTEK® ALC888 codec. It can support 2-channel or 7.1 channel sound under system configuration. Please follow the steps below to setup your sound system.

1. Install REALTEK HD Audio driver.
2. Lunch the control panel and Sound Effect Manager.

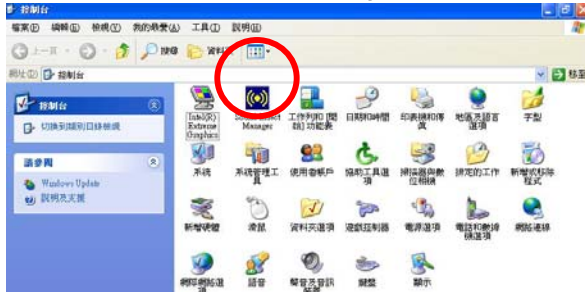

3. Select Speaker Configuration



4. Select the sound mode to meet your speaker system.

3.2 <Video Memory Setup>

Based on Intel® GM(E)965 chipset with GMA (Graphic Media Accelerator) X3100, the board supports Intel® DVMT (Dynamic Video Memory Technology) 4.0, which would allow the video memory to be allocated up to 384MB.

To support DVMT, you need to install the Intel GMA X3100 Driver with supported OS.

BIOS Setup:

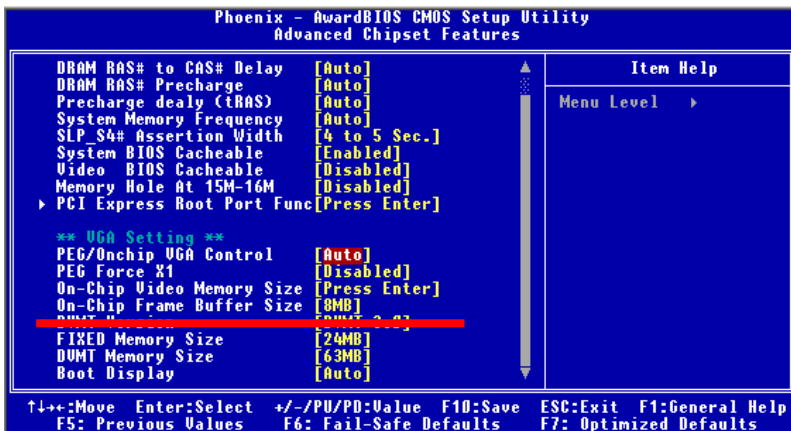

On-Chip Video Memory Size: This option combines three items below for setup.

On-Chip Frame Buffer Size:

This item can let you select video memory which been allocated for legacy VGA and SVGA graphics support and compatibility. The available option is **1MB** and **8MB**.

Fixed Memory Size:

This item can let you select a static amount of page-locked graphics memory which will be allocated during driver initialization. Once you select the memory amount, it will be no longer available for system memory.

DVMT Memory Size:

This item can let you select a maximum size of dynamic amount usage of video memory, the system would configure the video memory depends on your application, this item is strongly recommend to be selected as **MAX DVMT**.

Fixed + DVMT Memory Size:

You can select the fixed amount and the DVMT amount at the same time for a guaranteed video memory and additional dynamic video memory, please check the table below for available setting.

System Memory	On-Chip Frame Buffer Size	Fixed Memory Size	DVMT Memory Size	Total Graphic Memory
256MB ~ 511MB	1MB	128MB	0MB	128MB
	1MB	0MB	128MB	128MB
	8MB	128MB	0MB	128MB
	8MB	0	128MB	128MB
512MB~1023MB	1MB	128MB	0	128MB
	1MB	256MB	0	256MB
	1MB	0	128MB	128MB
	1MB	0	256MB	256MB
	8MB	128MB	0	128MB
	8MB	256MB	0	256MB
	8MB	0	128MB	128MB
	8MB	0	256MB	256MB
1024MB upper	1MB	128MB	0	128MB
	1MB	256MB	0	256MB
	1MB	0	128MB	128MB
	1MB	0	256MB	256MB
	1MB	0	MAX	384MB
	8MB	128MB	0	128MB
	8MB	256MB	0	256MB
	8MB	0	128MB	128MB
	8MB	0	256MB	256MB
8MB	0	MAX	384MB	

Notice:

1. The On-Chip Frame Buffer Size would be included in the Fixed Memory.

Please select the memory size according to this table.

3.3 <Display Properties Setting>

Based on Intel GM(E)965 GMCH with GMA X3100 (Graphic Media Accelerator), the board supports two DACs for display device as different resolution and color bit.

Please install the Intel Graphic Driver before you starting setup display devices.

1. Click right button on the desktop to lunch **display properties**

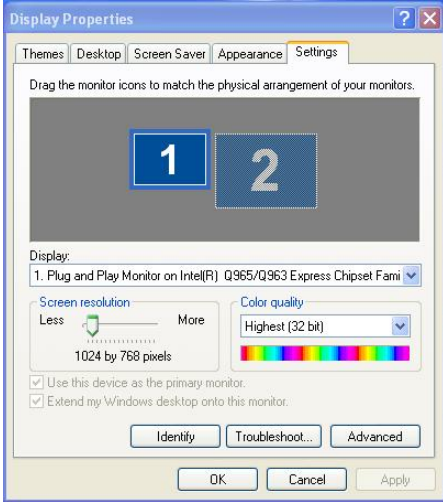

2. Click **Advanced** button for more specificity setup.

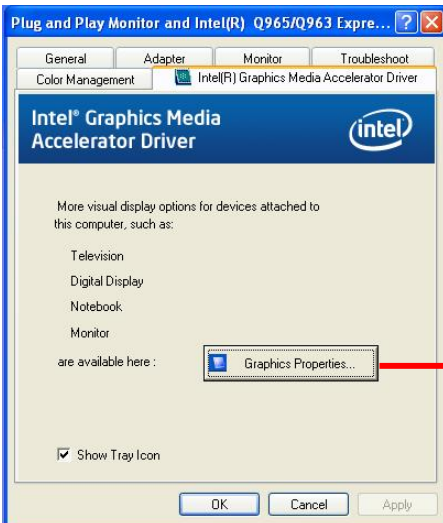

Click Graphics Properties... for advanced setup

3. This setup options can let you define each device settings.

Click **Monitor** to setup the CRT monitor for Colors, Resolution and Refresh Rate

Click **Intel® Dual Display Clone** to setup the dual display mode as same screen

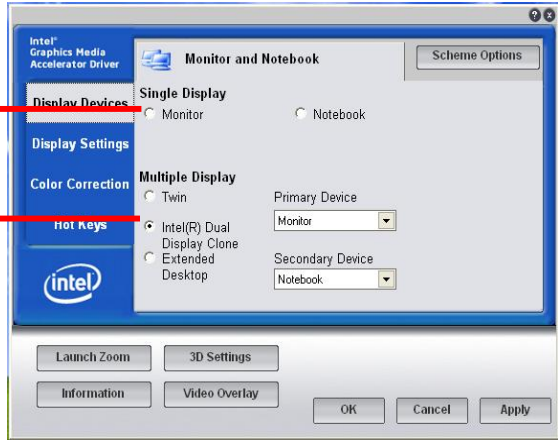

Chapter 4 <BIOS Setup>

The motherboard uses the Award BIOS for the system configuration. The Award BIOS in the single board computer is a customized version of the industrial standard BIOS for IBM PC AT-compatible computers. It supports Intel x86 and compatible CPU architecture based processors and computers. The BIOS provides critical low-level support for the system central processing, memory and I/O sub-systems.

The BIOS setup program of the single board computer let the customers modify the basic configuration setting. The settings are stored in a dedicated battery-backed memory, NVRAM, retains the information when the power is turned off. If the battery runs out of the power, then the settings of BIOS will come back to the default setting.

The BIOS section of the manual is subject to change without notice and is provided here for reference purpose only. The settings and configurations of the BIOS are current at the time of print, and therefore they may not be exactly the same as that displayed on your screen.

To activate CMOS Setup program, press key immediately after you turn on the system. The following message "Press DEL to enter SETUP" should appear in the lower left hand corner of your screen. When you enter the CMOS Setup Utility, the Main Menu will be displayed as **Figure 4-1**. You can use arrow keys to select your function, press <Enter> key to accept the selection and enter the sub-menu.

Figure 4-1 CMOS Setup Utility Main Screen

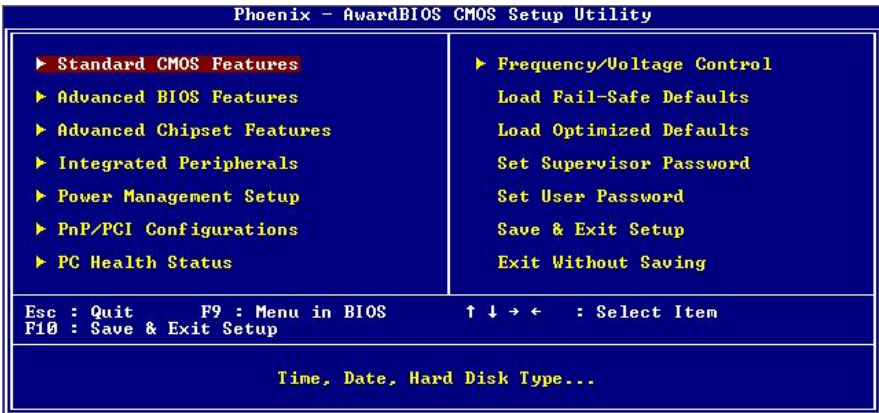

(This page is left for blank)

Appendix A <I/O Port Pin Assignment>

A.1 <IDE Port>

Connector: IDE1

Type: 44-pin (22 x 2) box header

Pin	Description	Pin	Description
1	Reset	2	Ground
3	D7	4	D8
5	D6	6	D9
7	D5	8	D10
9	D4	10	D11
11	D3	12	D12
13	D2	14	D13
15	D1	16	D14
17	D0	18	D15
19	Ground	20	N/C
21	REQ	22	Ground
23	-IOW	24	Ground
25	-IOR	26	Ground
27	IORDY	28	Ground
29	DACK	30	Ground
31	IDEIRQ	32	N/C
33	A1	34	66DET
35	A0	36	A2
37	-CS1	38	-CS3
39	-HD LED1	40	Ground

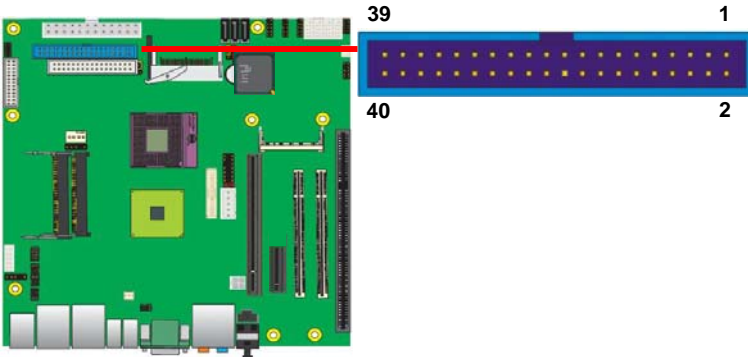

A.2 <Serial ATA Port>

Connector: **SATA1/2/3**

Type: 7-pin wafer connector

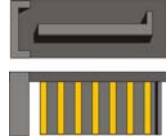

1	2	3	4	5	6	7	8	9
GND	RSATA_TXP1	RSATA_TXN1	GND	RSATA_RXN1	RSATA_RXP1	GND	GND	GND

A.3 <Floppy Port>

Connector: **FDD**

Type: 26-pin connector

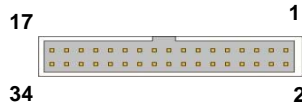

Pin	Description	Pin	Description
1	VCC	2	INDEX
3	VCC	4	DR0
5	VCC	6	DSKCHG
7	N/C	8	N/C
9	N/C	10	MTR0
11	DRVDE0	12	DIR
13	N/C	14	STEP
15	Ground	16	WRITE DATA
17	Ground	18	WRITE GATE
19	Ground	20	TRAK 0
21	N/C	22	WRPT0
23	Ground	24	RDATA-
25	Ground	26	HDSEL

A.4 <IrDA Port>

Connector: **CN_IR**

Type: 5-pin header for SIR Ports

JCSEL1 must jump to "IrDA"

Pin	Description
1	VCC
2	N/C
3	IRRX
4	Ground
5	IRTX



A.5 <Serial Port 1>

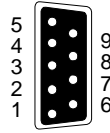

Connector: **COM1**

Type: 9-pin D-sub male connector on bracket

Pin	Description	Pin	Description
1	DCD- /+5V	6	DSR
2	SIN-	7	RTS
3	SO-	8	CTS
4	DTR-	9	RI /+12V
5	Ground		

A.6 <Serial Port 2>

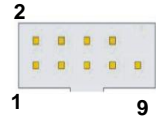

Connector: **COM2**

Type: 9-pin header connector on bracket

Pin	Description	Pin	Description
1	DCD- /485- /+5V	6	DSR
2	SIN- /485+	7	RTS
3	SO- /422+	8	CTS
4	DTR- /422-	9	RI /+12V
5	Ground		

A.7 <Serial Port 3/4/5/6>

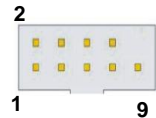

Connector: **COM3/4/5/6**

Type: 9-pin header connector on bracket

Pin	Description	Pin	Description
1	DCD- /+5V	6	DSR
2	SIN-	7	RTS
3	SO-	8	CTS
4	DTR-	9	RI /+12V
5	Ground		

A.8 <Parallel Port>

Connector: **LPT**

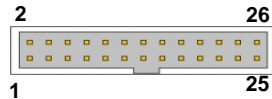

Type: 26-Pin header Connector on bracket

Pin	Description	Pin	Description
1	-PSTB	2	PRO0
3	PRO1	4	PRO2
5	PRO3	6	PRO4
7	PRO5	8	PRO6
9	PRO7	10	ACK-
11	BUSY	12	PE
13	SLCT	14	AFD-
15	ERR-	16	INT-
17	SLIN-	18	Ground
19	Ground	20	I/O Ground
21	Ground	22	Ground
23	Ground	24	Ground
25	Ground	26	N/C

A.9 <VGA Port>

Connector: **CRT**

Type: 15-pin D-sub female connector on bracket

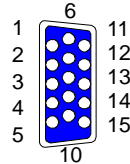

Pin	Description	Pin	Description	Pin	Description
1	RED	6	Ground	11	N/C
2	GREEN	7	Ground	12	DDCDA
3	BLUE	8	Ground	13	HSYNC
4	N/C	9	N/C	14	VSYNC
5	Ground	10	Ground	15	DDCCLK

A.10 <LAN Port>

Connector: **RJ45**

Type: RJ45 connector with LED on bracket



Pin	1	2	3	4	5	6	7	8
Description	MI0+	MI0-	MI1+	MI2+	MI2-	MI1-	MI3+	MI3-

A.11 < USB Interface >

Connector: **CN_USB**

Type: 10-pin (5 x 2) header for dual USB Ports

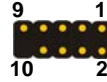

Pin	Description	Pin	Description
1	VCC	2	VCC
3	Data0-	4	Data1-
5	Data0+	6	Data1+
7	Ground	8	Ground
9	Ground	10	N/C

Appendix B <Flash BIOS>

B.1 <Flash Tool>

The board is based on Award BIOS and can be updated easily by the BIOS auto flash tool. You can download the tool online at the address below:

<http://www.phoenix.com/en/home/>
http://www.commell.com.tw/Support/Support_SBC.htm

File name of the tool is "awdfash.exe", it's the utility that can write the data into the BIOS flash ship and update the BIOS.

B.2 <Flash BIOS Procedure>















1. Please make a bootable floppy disk.
2. Get the last .bin files you want to update and copy it into the disk.
3. Copy awardflash.exe to the disk.
4. Power on the system and flash the BIOS. (Example: C:/ awardflash XXX.bin)
5. Restart the system.



































Any question about the BIOS re-flash please contact your distributors or visit the web-site at below:

<http://www.commell.com.tw/support/support.htm>

Appendix C <System Resources>





C1. <I/O Port Address Map>

	[00000000 - 0000000F]	Direct memory access controller
	[00000000 - 00000CF7]	PCI bus
	[00000010 - 0000001F]	Motherboard resources
	[00000020 - 00000021]	Programmable interrupt controller
	[00000022 - 0000003F]	Motherboard resources
	[00000040 - 00000043]	System timer
	[00000044 - 0000005F]	Motherboard resources
	[00000060 - 00000060]	Standard 101/102-Key or Microsoft Natural PS/2 Keyboard
	[00000061 - 00000061]	System speaker
	[00000062 - 00000063]	Motherboard resources
	[00000064 - 00000064]	Standard 101/102-Key or Microsoft Natural PS/2 Keyboard
	[00000065 - 0000006F]	Motherboard resources
	[00000070 - 00000073]	System CMOS/real time clock
	[00000074 - 0000007F]	Motherboard resources
	[00000080 - 00000090]	Direct memory access controller
	[00000091 - 00000093]	Motherboard resources
	[00000094 - 0000009F]	Direct memory access controller
	[000000A0 - 000000A1]	Programmable interrupt controller
	[000000A2 - 000000BF]	Motherboard resources
	[000000C0 - 000000DF]	Direct memory access controller
	[000000E0 - 000000EF]	Motherboard resources
	[000000F0 - 000000FF]	Numeric data processor
	[00000170 - 00000177]	Secondary IDE Channel
	[000001F0 - 000001F7]	Primary IDE Channel
	[00000274 - 00000277]	ISAPNP Read Data Port
	[00000279 - 00000279]	ISAPNP Read Data Port
	[000002E8 - 000002EF]	Communications Port (COM4)
	[000002F8 - 000002FF]	Communications Port (COM2)
	[00000376 - 00000376]	Secondary IDE Channel
	[00000378 - 0000037F]	Printer Port (LPT1)
	[00000380 - 0000038B]	Mobile Intel(R) 965 Express Chipset Family
	[000003C0 - 000003DF]	Mobile Intel(R) 965 Express Chipset Family
	[000003E8 - 000003EF]	Communications Port (COM3)
	[000003F0 - 000003F5]	Standard floppy disk controller

	[000003E8 - 000003EF]	Communications Port (COM3)
	[000003F0 - 000003F5]	Standard floppy disk controller
	[000003F6 - 000003F6]	Primary IDE Channel
	[000003F7 - 000003F7]	Standard floppy disk controller
	[000003F8 - 000003FF]	Communications Port (COM1)
	[00000400 - 000004BF]	Motherboard resources
	[000004D0 - 000004D1]	Motherboard resources
	[000004E8 - 000004EF]	Communications Port (COM6)
	[000004F8 - 000004FF]	Communications Port (COM5)
	[00000500 - 0000051F]	Intel(R) ICH8 Family SMBus Controller - 283E
	[00000778 - 0000077B]	Printer Port (LPT1)
	[00000880 - 0000088F]	Motherboard resources
	[00000A79 - 00000A79]	ISAPNP Read Data Port
	[00000D00 - 0000FFFF]	PCI bus
	[00009000 - 00009FFF]	Intel(R) ICH8 Family PCI Express Root Port 6 - 2849
	[00009F00 - 00009F1F]	Intel(R) PRO/1000 PL Network Connection #2
	[0000A000 - 0000AFFF]	Intel(R) ICH8 Family PCI Express Root Port 5 - 2847
	[0000AF00 - 0000AF1F]	Intel(R) PRO/1000 PL Network Connection
	[0000C000 - 0000CFFF]	Intel(R) ICH8 Family PCI Express Root Port 3 - 2843
	[0000D000 - 0000DFFF]	Intel(R) ICH8 Family PCI Express Root Port 2 - 2841
	[0000E000 - 0000EFFF]	Intel(R) ICH8 Family PCI Express Root Port 1 - 283F
	[0000F300 - 0000F30F]	Intel(R) ICH8M 3 port Serial ATA Storage Controller - 2828
	[0000F400 - 0000F40F]	Intel(R) ICH8M 3 port Serial ATA Storage Controller - 2828
	[0000F500 - 0000F503]	Intel(R) ICH8M 3 port Serial ATA Storage Controller - 2828
	[0000F600 - 0000F607]	Intel(R) ICH8M 3 port Serial ATA Storage Controller - 2828
	[0000F700 - 0000F703]	Intel(R) ICH8M 3 port Serial ATA Storage Controller - 2828
	[0000F800 - 0000F807]	Intel(R) ICH8M 3 port Serial ATA Storage Controller - 2828
	[0000F900 - 0000F90F]	Intel(R) ICH8M Ultra ATA Storage Controllers - 2850
	[0000FA00 - 0000FA1F]	Intel(R) ICH8 Family USB Universal Host Controller - 2832
	[0000FB00 - 0000FB1F]	Intel(R) ICH8 Family USB Universal Host Controller - 2831
	[0000FC00 - 0000FC1F]	Intel(R) ICH8 Family USB Universal Host Controller - 2830
	[0000FD00 - 0000FD1F]	Intel(R) ICH8 Family USB Universal Host Controller - 2835
	[0000FE00 - 0000FE1F]	Intel(R) ICH8 Family USB Universal Host Controller - 2834
	[0000FF00 - 0000FF07]	Mobile Intel(R) 965 Express Chipset Family



C2. <Memory Address Map>

[00000000 - 0009FFFF]	System board
[000A0000 - 000BFFFF]	Mobile Intel(R) 965 Express Chipset Family
[000A0000 - 000BFFFF]	PCI bus
[000C0000 - 000DFFFF]	PCI bus
[000E0000 - 000EFFFF]	System board
[000F0000 - 000FFFFF]	System board
[00100000 - 0F6DFFFF]	System board
[0F6E0000 - 0F6FFFFF]	System board
[0F700000 - 0F7FFFFF]	System board
[0F700000 - FEBFFFFF]	PCI bus
[D0000000 - DFFFFFFF]	Mobile Intel(R) 965 Express Chipset Family
[E0000000 - EFFFFFFF]	Motherboard resources
[FD100000 - FD1FFFFF]	Mobile Intel(R) 965 Express Chipset Family
[FD3FF000 - FD3FFFFF]	OHCI Compliant IEEE 1394 Host Controller
[FD500000 - FD5FFFFF]	Intel(R) ICH8 Family PCI Express Root Port 6 - 2849
[FD600000 - FD6FFFFF]	Intel(R) ICH8 Family PCI Express Root Port 6 - 2849
[FD6E0000 - FD6FFFFF]	Intel(R) PRO/1000 PL Network Connection #2
[FD700000 - FD7FFFFF]	Intel(R) ICH8 Family PCI Express Root Port 5 - 2847
[FD800000 - FD8FFFFF]	Intel(R) ICH8 Family PCI Express Root Port 5 - 2847
[FD8E0000 - FD8FFFFF]	Intel(R) PRO/1000 PL Network Connection
[FD900000 - FD9FFFFF]	Intel(R) ICH8 Family PCI Express Root Port 3 - 2843
[FDA00000 - FDAFFFFF]	Intel(R) ICH8 Family PCI Express Root Port 3 - 2843
[FDB00000 - FDBFFFFF]	Intel(R) ICH8 Family PCI Express Root Port 2 - 2841
[FDC00000 - FDCFFFFF]	Intel(R) ICH8 Family PCI Express Root Port 2 - 2841
[FDD00000 - FDDFFFFF]	Intel(R) ICH8 Family PCI Express Root Port 1 - 283F
[FDE00000 - FDEFFFFF]	Intel(R) ICH8 Family PCI Express Root Port 1 - 283F
[FDFF4000 - FDFF7FFF]	Microsoft UAA Bus Driver for High Definition Audio
[FDFFD000 - FDFFD0FF]	Intel(R) ICH8 Family SMBus Controller - 283E
[FDFFE000 - FDFFE3FF]	Intel(R) ICH8 Family USB2 Enhanced Host Controller - 2836
[FDFFF000 - FDFFF3FF]	Intel(R) ICH8 Family USB2 Enhanced Host Controller - 283A
[FEB00000 - FEBFFFFF]	Mobile Intel(R) 965 Express Chipset Family
[FEC00000 - FEC0FFFF]	System board
[FED13000 - FED1FFFF]	System board
[FED20000 - FED9FFFF]	System board























-  [FEE00000 - FEE00FFF] System board
-  [FFB00000 - FFB7FFFF] System board
-  [FFB80000 - FFBFFFFFF] Intel(R) 82802 Firmware Hub Device
-  [FFF00000 - FFFFFFFF] System board

C2. <System IRQ & DMA Resources>

DMA:

-  2 Standard floppy disk controller
-  4 Direct memory access controller

IRQ:

-  (ISA) 0 System timer
-  (ISA) 1 Standard 101/102-Key or Microsoft Natural PS/2 Keyboard
-  (ISA) 3 Communications Port (COM2)
-  (ISA) 4 Communications Port (COM1)
-  (ISA) 5 Communications Port (COM3)
-  (ISA) 6 Standard floppy disk controller
-  (ISA) 7 Communications Port (COM4)
-  (ISA) 8 System CMOS/real time clock
-  (ISA) 9 Microsoft ACPI-Compliant System
-  (ISA) 10 Communications Port (COM5)
-  (ISA) 11 Communications Port (COM6)
-  (ISA) 12 PS/2 Compatible Mouse
-  (ISA) 13 Numeric data processor
-  (ISA) 14 Primary IDE Channel
-  (ISA) 15 Secondary IDE Channel
-  (PCI) 9 Intel(R) ICH8 Family SMBus Controller - 283E
-  (PCI) 16 Intel(R) ICH8 Family PCI Express Root Port 1 - 283F
-  (PCI) 16 Intel(R) ICH8 Family PCI Express Root Port 5 - 2847
-  (PCI) 16 Intel(R) ICH8 Family USB Universal Host Controller - 2834
-  (PCI) 16 Intel(R) PRO/1000 PL Network Connection
-  (PCI) 16 Mobile Intel(R) 965 Express Chipset Family
-  (PCI) 17 Intel(R) ICH8 Family PCI Express Root Port 2 - 2841
-  (PCI) 17 Intel(R) ICH8 Family PCI Express Root Port 6 - 2849
-  (PCI) 17 Intel(R) PRO/1000 PL Network Connection #2
-  (PCI) 18 Intel(R) ICH8 Family PCI Express Root Port 3 - 2843
-  (PCI) 18 Intel(R) ICH8 Family USB Universal Host Controller - 2832
-  (PCI) 18 Intel(R) ICH8 Family USB2 Enhanced Host Controller - 283A
-  (PCI) 19 Intel(R) ICH8 Family USB Universal Host Controller - 2831
-  (PCI) 19 Intel(R) ICH8M 3 port Serial ATA Storage Controller - 2828
-  (PCI) 21 Intel(R) ICH8 Family USB Universal Host Controller - 2835
-  (PCI) 22 Microsoft UAA Bus Driver for High Definition Audio
-  (PCI) 23 Intel(R) ICH8 Family USB Universal Host Controller - 2830
-  (PCI) 23 Intel(R) ICH8 Family USB2 Enhanced Host Controller - 2836
-  (PCI) 23 OHCI Compliant IEEE 1394 Host Controller

Appendix D <Programming GPIO's>

The GPIO' can be programmed with the MSDOS debug program using simple IN/OUT commands. The following lines show an example how to do this.

```
GPIO0.....GPIO7  bit0.....bit7
-o 2E 87                ;enter configuration
-o 2E 87
-o 2E 07
-o 2F 09                ;enable GPIO function
-o 2E 30
-o 2F 02                ;enable GPIO configuration
-o 2E F0
-o 2F xx                ;set GPIO as input/output; set '1' for input,'0'for
output
-o 2E F1
-o 2F xx                ;if set GPIO's as output, in this register its value
can be set
```

Optional :

```
-o 2E F2
-o 2F xx                ; Data inversion register ; '1' inverts the current
values of the bits ,'0' leaves them as they are
-o 2E 30
-o 2F 01                ; active GPIO's
```

For further information, please refer to Winbond W83627DHG datasheet.

Appendix E <Programming Watchdog Timer >

The watchdog timer makes the system auto-reset while it stops to work for a period. The integrated watchdog timer can be setup as system reset mode by program.

Timeout Value Range

- 1 to 255
- Second or Minute

Program Sample

Watchdog timer setup as system reset with 5 second of timeout

```

2E, 87
2E, 87
2E, 07
2F, 08      Logical Device 8
2E, 30      Activate
2F, 01
2E, F5      Set as Second*
2F, 00
2E, F6      Set as 5
2F, 05
    
```

* Minute: bit 3 = 0; Second: bit 3 = 1

You can select Timer setting in the BIOS, after setting the time options, the system will reset according to the period of your selection.



Appendix F <How to setting RS-422,RS-485 & IrDA>

Function	JCSEL1	JCSEL2
IrDA		
RS-422		
RS-485		
RS-232		

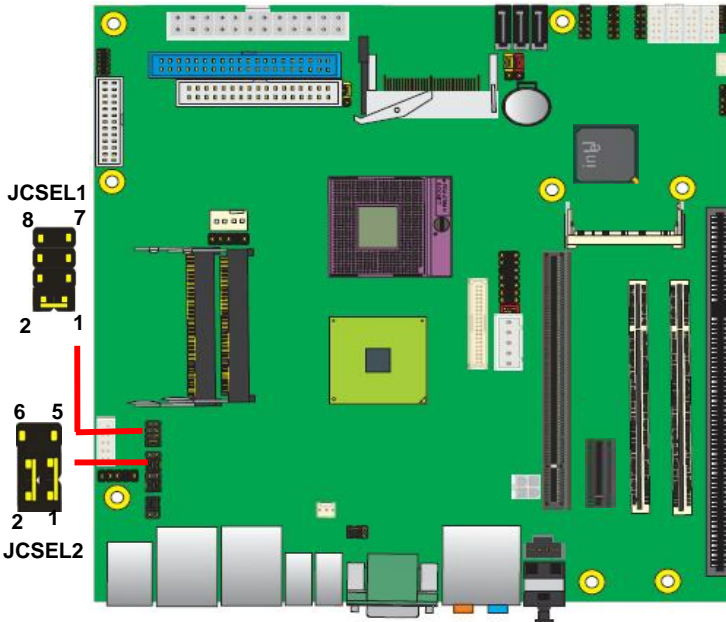

Contact Information

Any advice or comment about our products and service, or anything we can help you please don't hesitate to contact with us. We will do our best to support you for your products, project a business.

Taiwan Commate Computer Inc.

Address 8F, No. 94, Sec. 1, Shin Tai Wu Rd., Shi Chih
Taipei Hsien, Taiwan

TEL +886-2-26963909

FAX +886-2-26963911

Website <http://www.commell.com.tw>

E-Mail info@commell.com.tw (General Information)
tech@commell.com.tw (Technical Support)

Commell is a brand name of Taiwan commate computer Inc.