

LV-67T

Mini-ITX Motherboard

User's Manual

Edition 2.0
2021/07/19

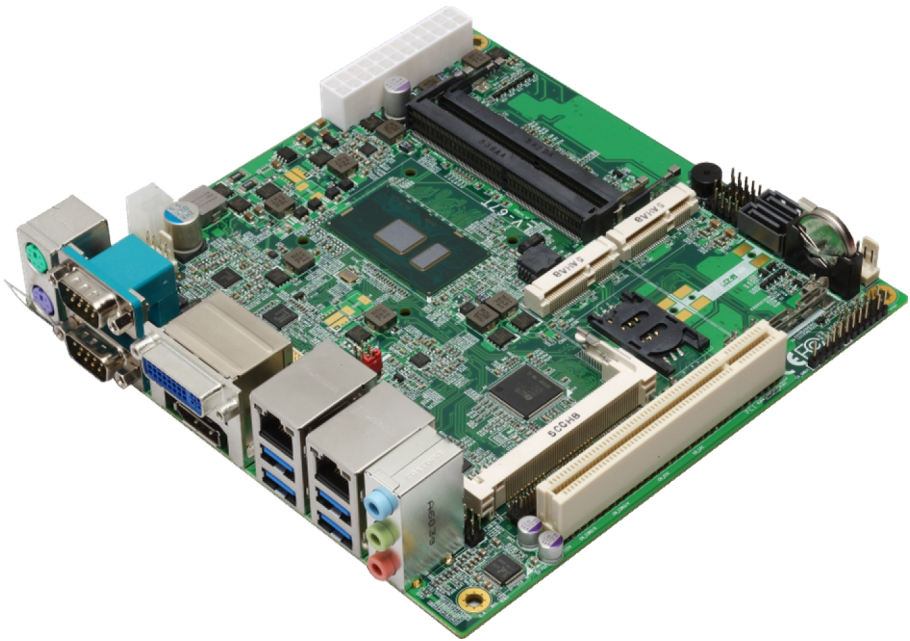

Copyright

Copyright 2021, all rights reserved. This document is copyrighted and all rights are reserved. The information in this document is subject to change without prior notice to make improvements to the products.

This document contains proprietary information and protected by copyright. No part of this document may be reproduced, copied, or translated in any form or any means without prior written permission of the manufacturer.

All trademarks and/or registered trademarks contains in this document are property of their respective owners.

Disclaimer

The company shall not be liable for any incidental or consequential damages resulting from the performance or use of this product.

The company does not issue a warranty of any kind, express or implied, including without limitation implied warranties of merchantability or fitness for a particular purpose.

The company has the right to revise the manual or include changes in the specifications of the product described within it at any time without notice and without obligation to notify any person of such revision or changes.

Trademark

All trademarks are the property of their respective holders.

Any questions please visit our website at <http://www.commell.com.tw>

Packing List:

Please check the package content before you starting using the board.



1 x LV-67T Mini-ITX Motherboard



1 x Standard Cooler Fan (included)
(OHS-P-M-7) / (2181010002)



2 x SATA Cable
(OALSATA3-L / 1040529)

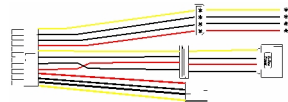

1 x Power Cable
(OALATX-P3S2) / (1040058)



1 x DC Power Cable
(OALDC-A) / (1040433)

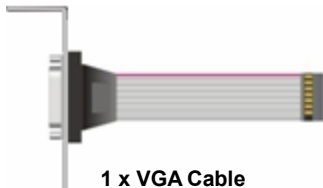

1 x VGA Cable
(OALVGA-S) / (1040552)

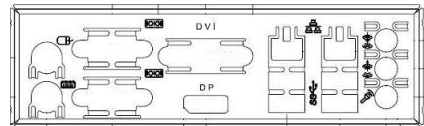

1 x I/O Shield
(OPLATE-MCDLA) / (1270055)

Optional:

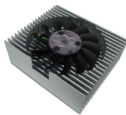

OEM Cooler Fan (Smart Fan)
(OHSF-4-01) / (2181110029)

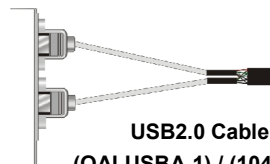

USB2.0 Cable
(OALUSBA-1) / (1040172)



Dual COM cable
(OALES-BKU2) / (1040087)

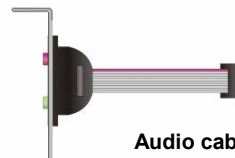

Audio cable
(OALPJ-HD) / (1040120)

Printed Matters:

Driver CD (Including User's Manual) x 1

Index

Chapter 1 <Introduction>	4
1.1 <Product Overview>.....	4
1.2 <Product Specification>	5
1.3 <Mechanical Drawing>.....	6
1.4 <Block Diagram>.....	8
Chapter 2 <Hardware setup>	9
2.1 <Connector Location and Reference>	9
2.1.1 <Internal connectors list>	10
2.1.2 <External connectors list>	10
2.2 <Jumper Location and Reference>	11
2.2.1 <Jumper list>	11
2.2.2 <Clear CMOS and Power on type selection>	11
2.3 <Installing the Memory>	12
2.4 <I/O interface>	13
2.4.1 <Serial ATA interface>	13
2.4.2 <Ethernet interface>.....	13
2.4.3 <Display interface>	14
2.4.4 <Serial Port interface>	16
2.4.5 <USB interface>.....	18
2.4.6 <Audio interface>	18
2.4.7 <Expansion slot>.....	19
2.4.8 <Front panel switch and indicator>	20
2.4.9 < GPIO ,SMBUS and Other Interface >	21
2.5 <Power supply>	23
2.5.1 <Power input>.....	23
2.5.2 <Power output>.....	24
Appendix A <Flash BIOS>	25
Appendix B <Win7 Installation Notes>	26
Appendix C <LCD Panel Type select>	27
Appendix D <Programmable GPIO >	28
Appendix E <Programmable Watch Dog Timer>	29
Appendix F <SATA RAID function setting>	30
Contact information	30

Chapter 1 <Introduction>

1.1 <Product Overview>

LV-67T is Mini-ITX Motherboard which supports 6th / 7th Generation Intel® Core™ U-series i7, i5, i3, Celeron Mobile Processor with Sunrise Point PCH-LP, integrated HD Graphics, DDR4 memory, Realtek High Definition Audio, Intel Gigabit LAN, Serial ATA3 with AHCI function for a system.

Intel Skylake-U/ Kaby Lake-U Processor with Sunrise Point PCH-LP

The 6th / 7th Generation Intel® Core™ U-series processor family is the next generation, multi-core mobile processor built on 14 nanometer process with MCP technology.

The Skylake-U/Kaby Lake-U have a lower TDP, it provides new HD Graphics support triple display at the same time, maximum supported is up to 32GB of DDR4, better performance, flexibility and more enhanced security that is suitable for a variety of intelligent systems the ideal choice.

All in One multimedia solution

The board provides high performance onboard graphics, 24-bit dual channel LVDS interface, DisplayPort/VGA, DVI, and High Definition Audio, to meet the very requirement of the multimedia application.

Flexible Expansion Interface

The board provides two MiniPCIe and support mSATA, SIM.

Kaby Lake only support Windows10 64bit

Intel only support Windows 10 64bit. It may lose some drivers if you use other Windows version.

1.2 <Product Specification>

System

Processor	Intel® 6 th / 7 th Gen Core™ U-series Processor, FCBGA1356 package
Chipset	Sunrise Point-LP
Memory	2 x DDR4 SO-DIMM 1866/2133 MHz up to 32GB Support Non-ECC memory
Watchdog Timer	Generates a system reset with internal timer for 1min/s ~ 255min/s
Real Time Clock	Chipset integrated RTC with onboard lithium battery
Expansion	2 x MiniPCIe (Card2 support mSATA) and half-size choosable, 1 x SIM slot 1 x PCI slot 1 x MiniPCI slot

Graphics

Chipset	Intel® Gen 9 integrated HD Graphics
Display Interface	1 x DVI-I, 1 x LVDS, 1 x DisplayPort/VGA

LAN

Chip	1 x Intel® I210-AT Gigabit LAN 1 x Intel® I219-LM Gigabit PHY LAN (Support iAMT11.0)
------	---

I/O

Serial ATA	2 x SATA3 support RAID 0, 1
Audio	Realtek ALC262 HD Audio
Digital I/O	Programmable 8-bit GPIO with 12 pin-header
Internal I/O	2 x SATA3, 4 x RS232, 4 x USB2.0, 1 x LVDS, 1 x Audio 1 x LCD inverter, 1 x LPC, 1 x SMBUS, 1 x DIO, 1 x VGA
Rear I/O	1 x RS232, 1 x RS232/422/485, 1 x DVI-I, 1 x DisplayPort, 4 x USB3.0, 2 x LAN, 1 x PS/2, 1 x Audio Jack

Mechanical & Environmental

Power Requirement	ATX or DC input 9~30V
Size	170mm x 170mm (L x W)
Temperature	Operating within 0°C~60°C (32°F~140°F) Storage within -20°C~80°C (-4°F~176°F)
Relative Humidity	10%~90%, non-condensing

1.3 <Mechanical Drawing>

Positive

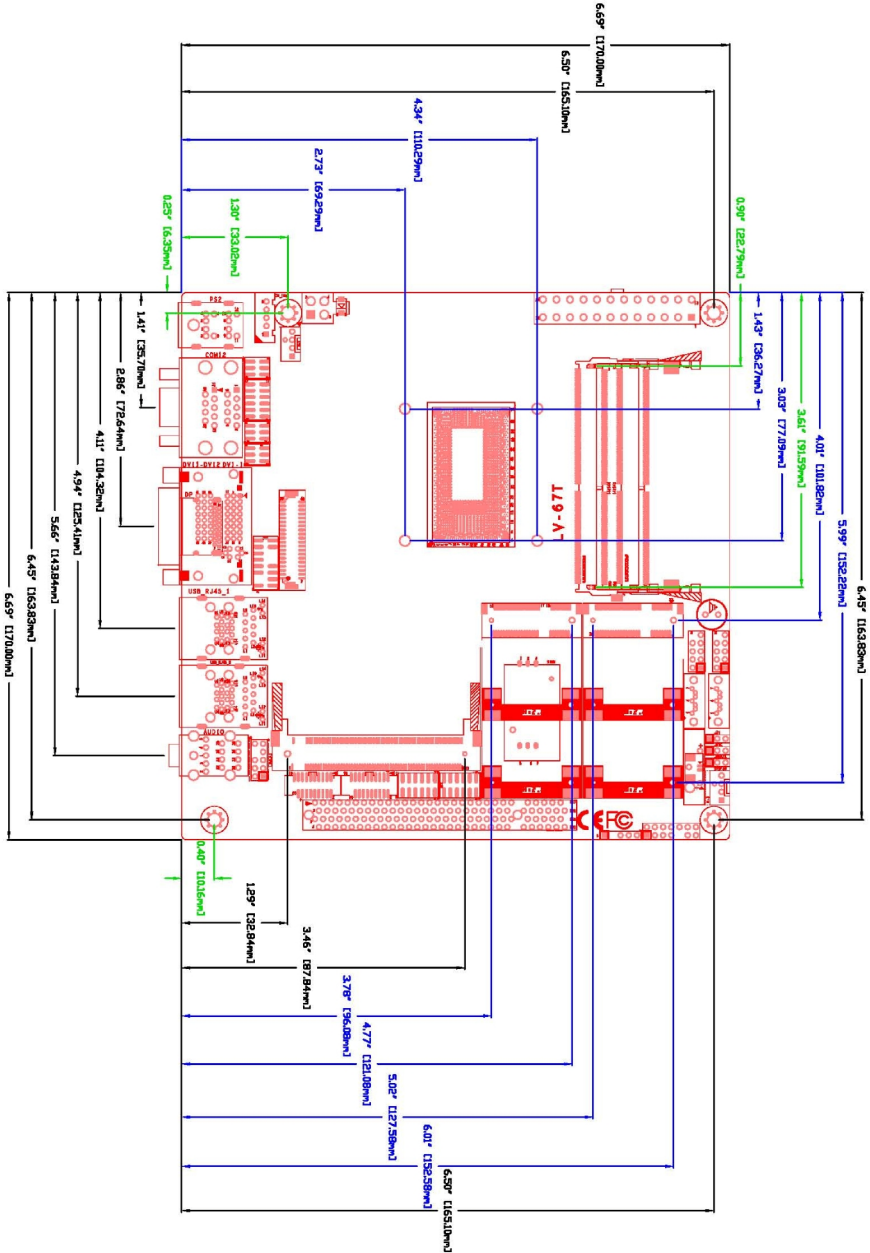

I/O

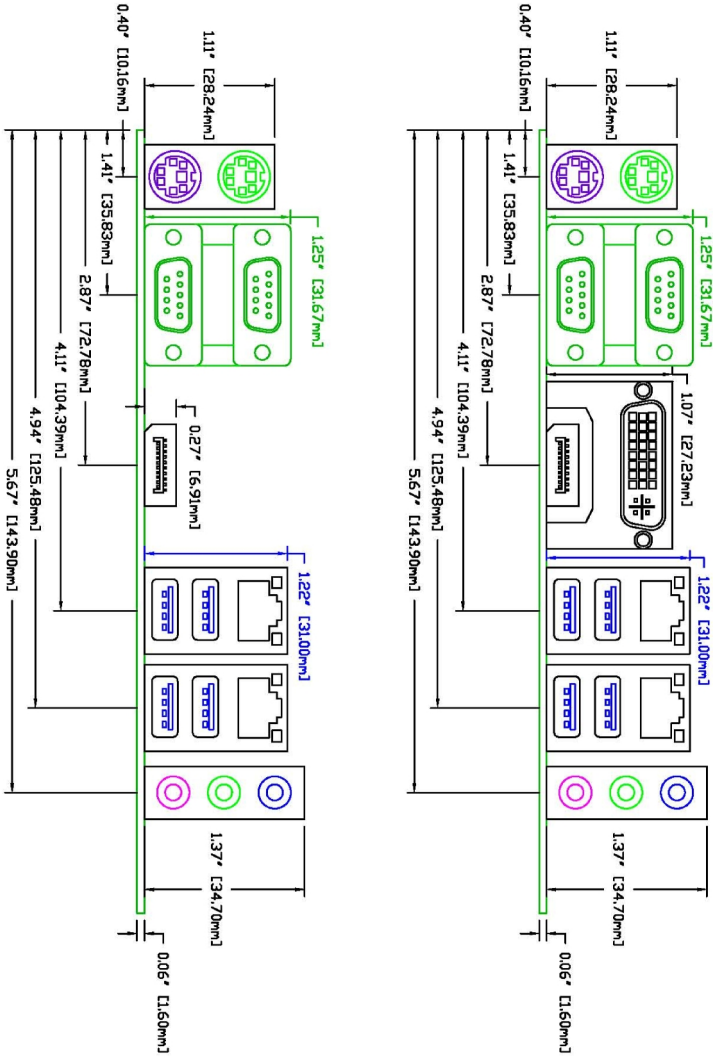

1.4 <Block Diagram>

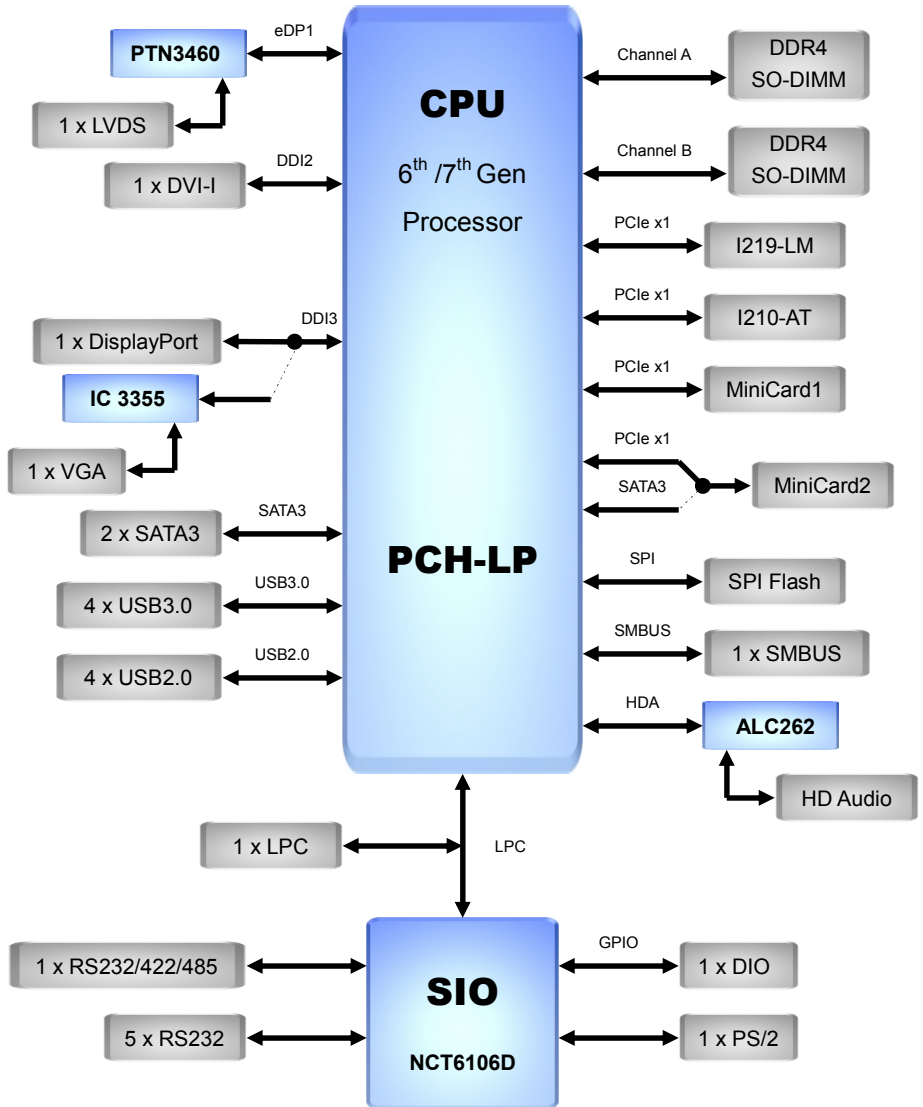

Chapter 2 <Hardware setup>

2.1 <Connector Location and Reference>

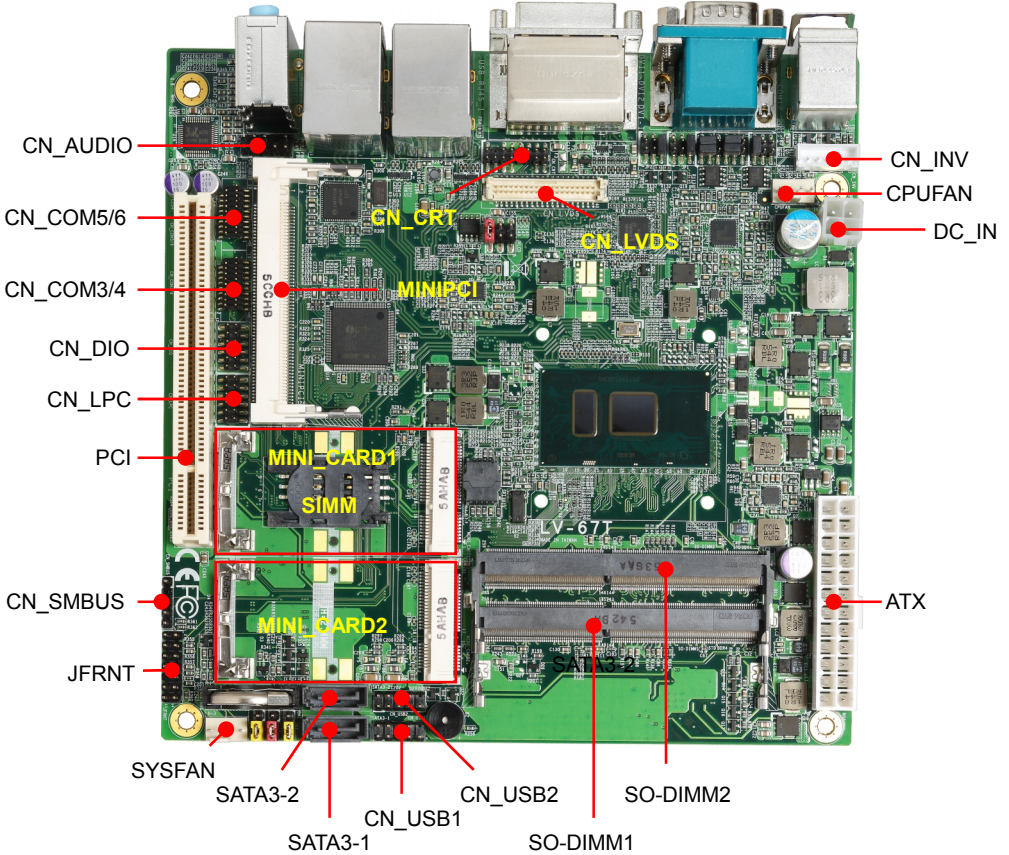

PS2	COM2	DVI-I	LAN1	LAN2	Audio
	COM1	DisplayPort	USB3.0	USB3.0	

2.1.1 <Internal connectors list>

Connector	Function
SO-DIMM1/2	260-pin DDR4 SO-DIMM slot
SATA3-1/2	7-pin Serial ATA3 connector
CN_AUDIO	5 x 2-pin audio pin header
CN_LPC	6 x 2-pin LPC pin header
CN_DIO	6 x 2-pin General Purpose In/Out pin header
CN_LVDS	20 x 2-pin LVDS connector
CN_CRT	8 x 2-pin VGA pin header
CN_INV	5-pin LCD inverter connector
CN_COM3/4	20-pin RS232 pin header
CN_COM5/6	20-pin RS232 pin header
CN_USB1/2	5 x 2-pin USB2.0 pin header
SMBUS	5-pin SMBus pin header
SIMM	6-pin SIM card slot
CPUFAN	4-pin CPU fan connector
SYSFAN	4-pin system fan connector
JFRNT	5 x 2-pin front panel switch/indicator pin header
MINI_CARD1/2	52-pin MiniPCIe card slot
MINIPCI	124-pin MiniPCI card slot
PCI	120-pin PCI card slot
DC_IN	ATX12V connector support DC 9~30V input
ATX	20+4-pin main power connector

2.1.2 <External connectors list>

Connector	Function
PS2	PS/2 female connector for keyboard and mouse
COM1/2	DB9 male connector
DVI	DVI-I dual link connector
DisplayPort	DisplayPort connector
USB3.0	USB3.0 connector
LAN1/2	RJ45 connector
AUDIO	Audio jack support Line-in, Line-out, Mic-in

2.2 <Jumper Location and Reference>

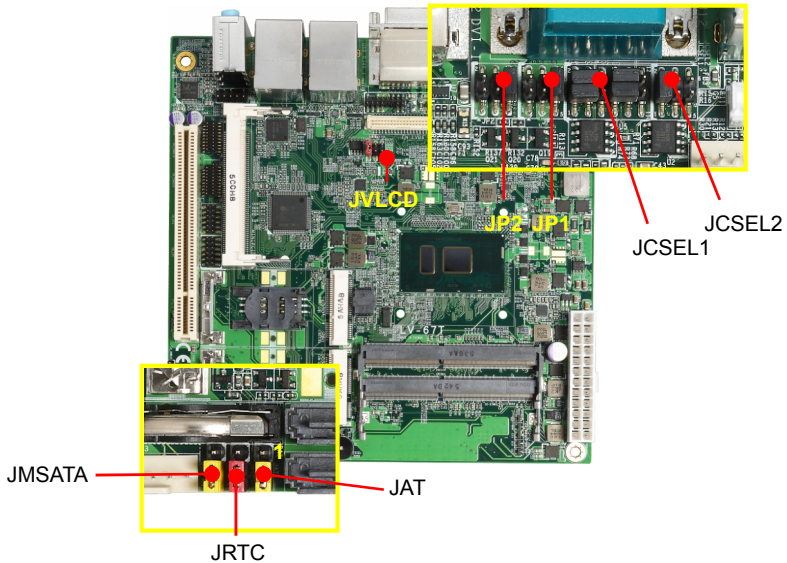

2.2.1 <Jumper list>

Jumper	Function
JAT	Power mode select
JRTC	CMOS Normal/Clear Setting
JVLCD	Panel Voltage Setting
JMSATA	MiniCard2 mSATA Setting
JCSEL1/2	COM2 RS232/422/485 select
JP1/2	COM1 and COM2 9-pin setting

2.2.2 <Clear CMOS and Power on type selection>

JRTC: Clear CMOS data jumper

Jumper settings	Function
1-2	Clear CMOS
2-3	Normal (Default)

JAT: AT/ATX mode select jumper

Jumper settings	Function
1-2	AT mode
2-3	ATX mode (Default)

2.3 <Installing the Memory>

In the process, the board must be powered off.

1. Put the memory tilt into the slot. Note the Memory notch key aligned slot key.
2. Then press down till lock into the mounting notch.

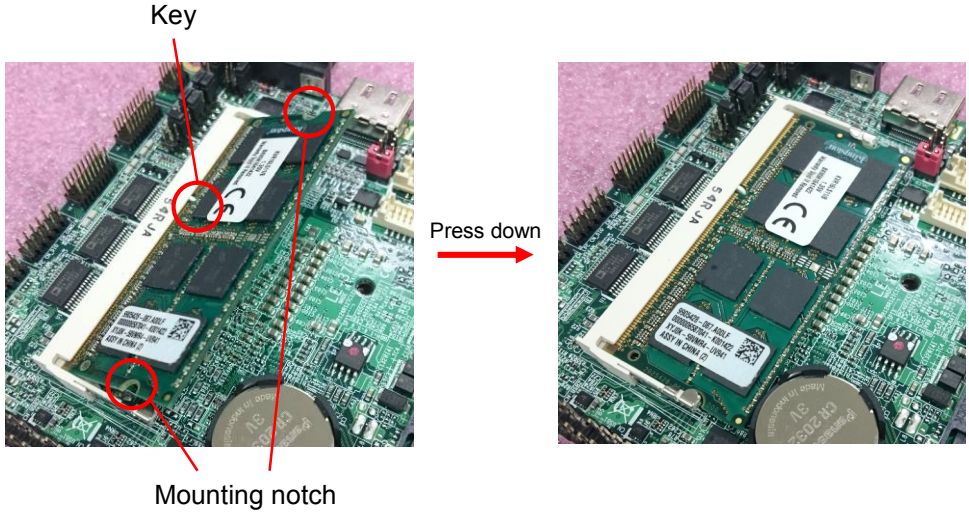

3. To remove the memory, push outward on both sides of the latch.

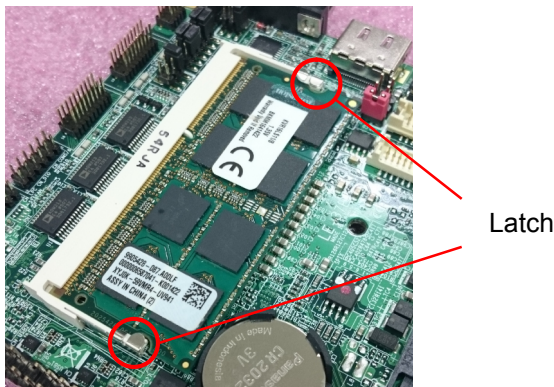

2.4 <I/O interface>

2.4.1 <Serial ATA interface>

Support RAID0 and 1.

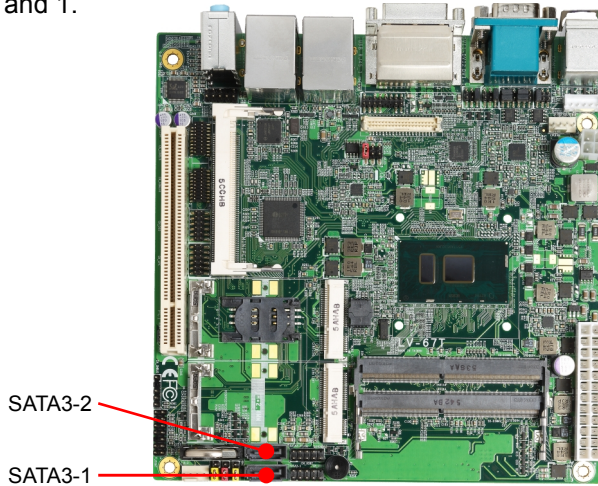

2.4.2 <Ethernet interface>

The board provides I210-AT and I219-LM Gigabit Ethernet which supports WOL on rear I/O.

It supports Intel® AMT 11.0 feature on I219-LM.

(Note that the CPU must support vPro technology, ex: [i5-6300U](#))

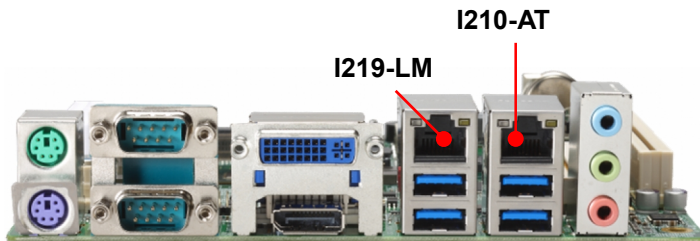

2.4.3 <Display interface>

Based on the 6th / 7th Gen CPU with built-in HD Graphics, the DisplayPort resolution up to **3840x2160 @ 60Hz** or **4096x2304 @ 60Hz**, and LVDS up to **1920x1200 @ 60Hz** support 18/24-bit color depth and dual channel. About select LCD Panel Type in BIOS, please refer [Appendix C](#).

The VGA resolution is up to **2048x1536 @50Hz**.

The built-in HD Graphics support triple display function with clone mode and extended mode.

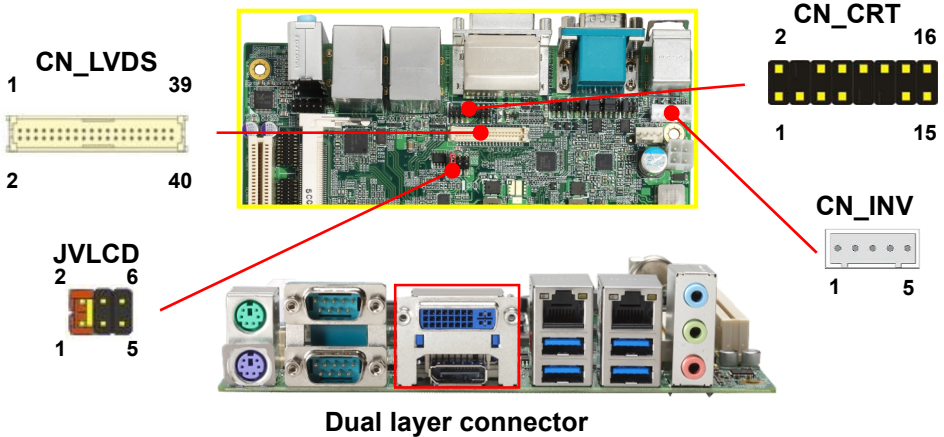

Dual layer connector

Note1: The DVI-DP dual layer connector can be changed to dual DVI-D, and the VGA will no function.

Note2: Onboard DP/VGA connector for plug option, (VGA function is the first priority if plug DP/VGA at the same time).

CN_CRT: VGA 16-pin header (Pitch 2.00mm)

Pin	Signal	Pin	Signal
1	RED	2	GREEN
3	BLUE	4	Key
5	DETECT	6	GND
7	GND	8	GND
9	Key	10	DETECT
11	Key	12	SDA
13	HSYNC	14	VSYNC
15	SCL	16	NC

Note that pin 5, 10 active low.

CN_LVDS: LVDS 40-pin connector (Model: HIROSE DF13-40DP-1.25V compatible)

Pin	Signal	Pin	Signal
2	Set by JVLCD	1	Set by JVLCD
4	Detect (Active low)	3	GND
6	A_LVDS_0-	5	B_LVDS_0-
8	A_LVDS_0+	7	B_LVDS_0+
10	GND	9	GND
12	A_LVDS_1-	11	B_LVDS_1-
14	A_LVDS_1+	13	B_LVDS_1+
16	GND	15	GND
18	A_LVDS_2-	17	B_LVDS_2-
20	A_LVDS_2+	19	B_LVDS_2+
22	GND	21	GND
24	A_LVDS_CLK-	23	B_LVDS_3-
26	A_LVDS_CLK+	25	B_LVDS_3+
28	GND	27	GND
30	A_LVDS_3-	29	B_LVDS_CLK-
32	A_LVDS_3+	31	B_LVDS_CLK+
34	GND	33	GND
36	LVDS_DDCSCL	35	NC
38	LVDS_DDCSDA	37	NC
40	NC	39	NC

Note: Pin4 only need to be connected to GND

CN_INV: LVDS 5-pin Backlight power connector

Pin	Signal
1	12V
2	Backlight Control
3	GND
4	GND
5	Enable Backlight

JVLCD: LVDS panel power select jumper

Jumper settings	Function
1-2	3.3V (Default)
3-4	5V
5-6	12V

Effective patterns of connection: 1-2 / 3-4 / 5-6

Other may cause damage

2.4.4 <Serial Port interface>

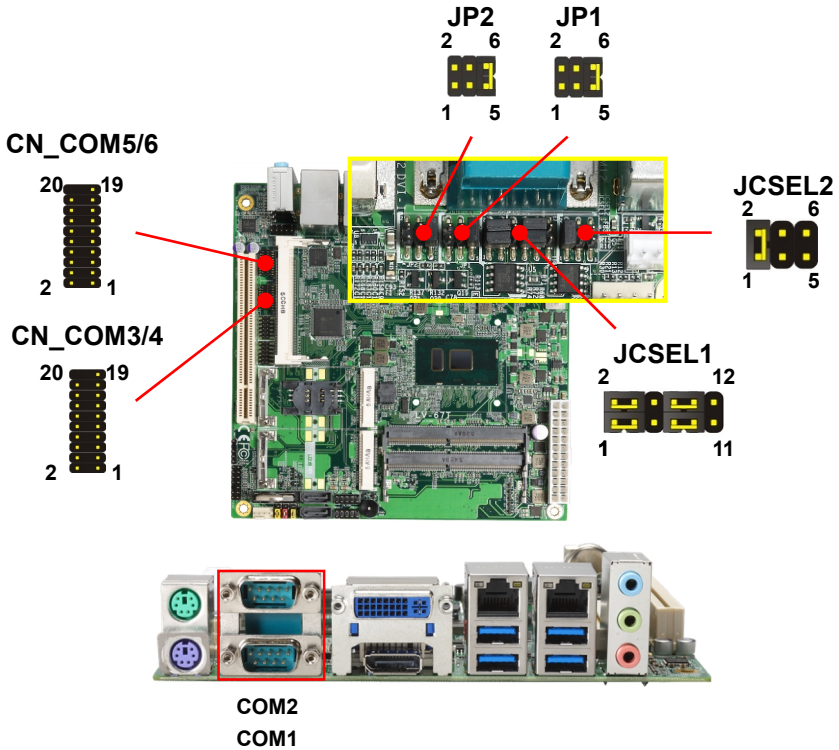

COM1: RS232 DB9 connector

Pin	Signal	Pin	Signal
1	DCD	2	RXD
3	TXD	4	DTR
5	GND	6	DSR
7	RTS	8	CTS
9	Set by JP2		

COM2: RS232/422/485 DB9 connector

Pin	Signal	Pin	Signal
1	DCD/ 422TX-/ 485-	2	RXD/ 422TX+/ 485+
3	TXD/ 422RX+	4	DTR/ 422RX-
5	GND	6	DSR
7	RTS	8	CTS
9	Set by JP1		

Note: Use JCSEL1 and JCSEL2 to select communication mode

COM3/4,5/6: RS232 20-pin header (Pitch 1.27mm x 2.54mm)

Pin	Signal	Pin	Signal
1	DCD1	2	RXD1
3	TXD1	4	DTR1
5	GND	6	DSR1
7	RTS1	8	CTS1
9	RI1	10	NC
11	DCD2	12	RXD2
13	TXD2	14	DTR2
15	GND	16	DSR2
17	RTS2	18	CTS2
19	RI2	20	Key







JP1, JP2: COM1, COM2 pin-9 setting

Jumper settings	Function
1-2	5V
3-4	12V
5-6	RI (Default)

Effective patterns of connection: 1-2 / 3-4 / 5-6

Other may cause damage

JCSEL1, JCSEL2: For configure COM2 communication mode

Function	JCSEL1	JCSEL2
RS232		
RS485		
RS422		

2.4.5 <USB interface>

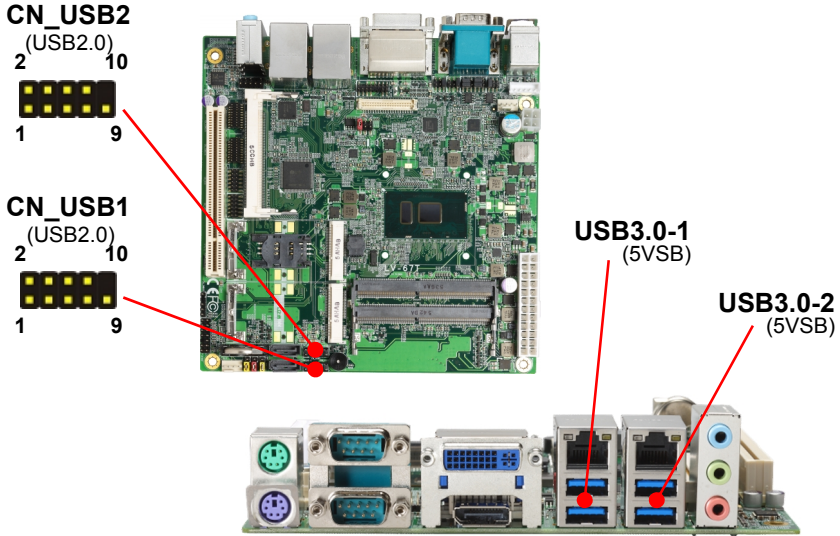

CN_USB1/2: Front panel USB2.0 10-pin header (Pitch 2.54mm)

Pin	Signal	Pin	Signal
1	5VSB	2	5VSB
3	DATA0-	4	DATA1-
5	DATA0+	6	DATA1+
7	GND	8	GND
9	GND	10	Key

Install USB3.0 Driver if you want to use CN_USB 2-1/2-2 in Windows7.

2.4.6 <Audio interface>

Rear Audio Jack



CN_AUDIO

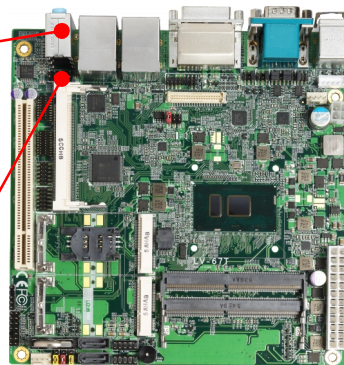

CN_AUDIO: Front panel audio 10-pin header (Pitch 2.54mm)

Pin	Signal	Pin	Signal
1	MIC_L	2	GND
3	MIC_R	4	NC
5	FP_OUT_R	6	MIC_DETECT
7	SENSE	8	Key
9	FP_OUT_L	10	FP_OUT_DETECT

2.4.7 <Expansion slot>

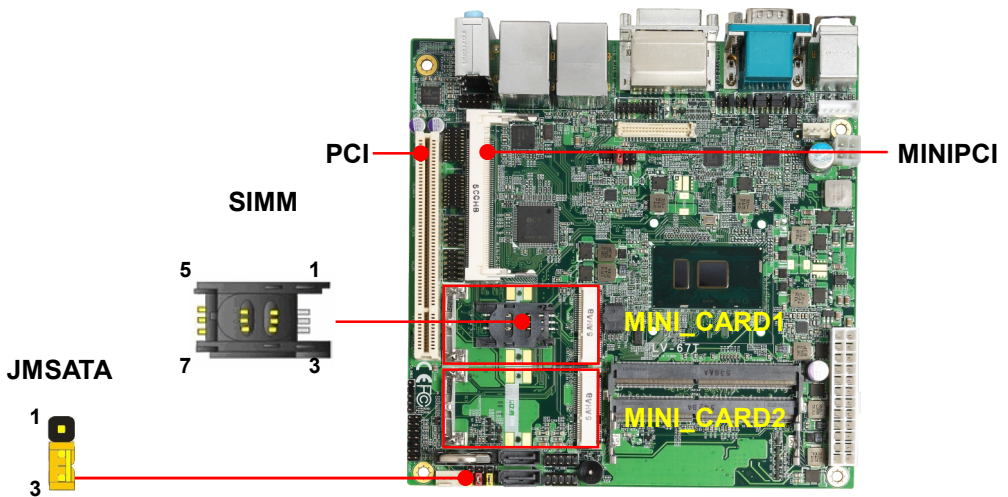

MINI_CARD1 and MINI_CARD2 have special design to compatible our MiniPCIe card (ex: MPX-574D2, MPX-210D2 etc) and MINI_CARD2 supports mSATA set by JMSATA.

MINI_CARD1 supports SIM card to use 3G module.

JMSATA: Setting MINI_CARD2 to support PCIe/mSATA

Jumper settings	Function
1-2	Support mSATA
2-3	Normal operation (Default)

SIMM: (3G MiniPcie Mode)

Pin	Signal	Pin	Signal
1	SIMVCC	2	SIMRST
3	SIMCLK	4	NC
5	GND	6	SIMVPP
7	SIMDATA		

<SIM>

This is for 3G miniPCie card which doesn't have SIM slot.

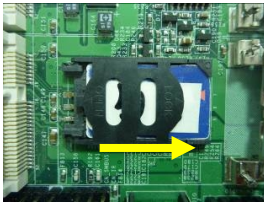
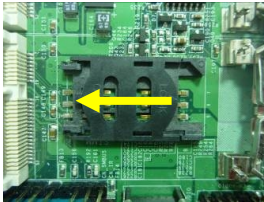

Slide the direction of the arrow open the cover.

Then press down and slide the direction of the arrow close the cover.

Insert the SIM card and make sure the direction is correct

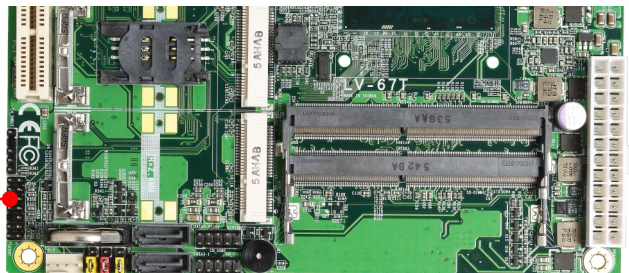
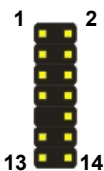
2.4.8 <Front panel switch and indicator>
JFRNT

JFRNT: Front panel switch and indicator 14-pin header (Pitch 2.54mm)

Pin	Signal	Pin	Signal
1	HDD_LED+	2	Power_LED+
3	HDD_LED-	4	NC
5	Reset+	6	Power_LED-
7	Reset-	8	Speaker+
9	Key	10	NC
11	Power_ON+	12	NC
13	Power_ON-	14	Speaker-

2.4.9 < GPIO ,SMBUS and Other Interface >

The board provides a programmable 8-bit digital I/O interface; you can use this general purpose I/O port for system control like POS or KIOSK. The GPIO is an **Open-drain output** and **TTL-level input**.

1. Output : **Open-drain**, Most applications **need use an external pull-up resistor**.
2. Input : **TTL-level**.

DC characteristics:

5V TTL-level Input Pin

Parameter	Sym	Min	Typ	Max	Unit	Conditions
Input Low Threshold Voltage	V_{t-}	0.5	0.8	1.1	V	$V_{CC} = 3.3V$
Input High Threshold Voltage	V_{t+}	1.6	2.0	2.4	V	$V_{CC} = 3.3V$
Hysteresis	V_{TH}	0.5	1.2		V	$V_{CC} = 3.3V$
Input High Leakage	I_{LH}			+10	μA	$V_{IN} = 3.3V$
Input Low Leakage	I_{Ll}			-10	μA	$V_{IN} = 0V$

Open-drain output pin with 12-mA sink capability

Output Low Voltage	V_{OL}			0.4	V	$I_{OL} = 12\text{ mA}$
--------------------	----------	--	--	-----	---	-------------------------

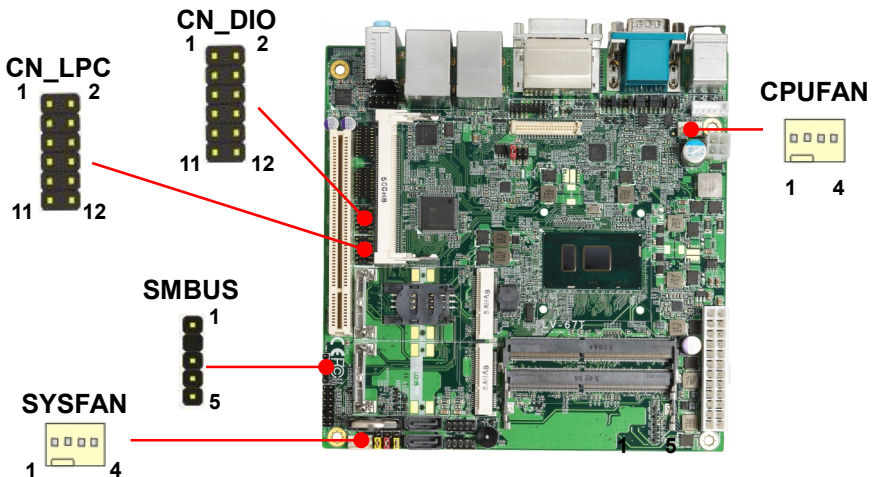

CN_DIO: GPIO 12-pin header (Pitch 2.00mm)

Pin	Signal	Pin	Signal
1	GND	2	GND
3	GPIO0	4	GPIO4
5	GPIO1	6	GPIO5
7	GPIO2	8	GPIO6
9	GPIO3	10	GPIO7
11	5V	12	12V

CN_LPC: LPC 12-pin header (Pitch 2.00mm)

Pin	Signal	Pin	Signal
1	CLK	2	RST
3	-LFRAME	4	LAD3
5	LAD2	6	LAD1
7	LAD0	8	3.3V
9	SERIRQ	10	GND
11	3.3VSB	12	NC

Note: Support TPM module.

SMBUS: SMBus 5-pin connector

Pin	Signal
1	5V
2	NC
3	SMBDAT
4	SMBCLK
5	GND

CPUFAN: CPU cooler fan 4-pin connector

Pin	1	2	3	4
Signal	GND	12V	Sensor	Control

SYSFAN: System cooler fan 4-pin connector

Pin	1	2	3	4
Signal	GND	12V	Sensor	Control

2.5 <Power supply>

2.5.1 <Power input>

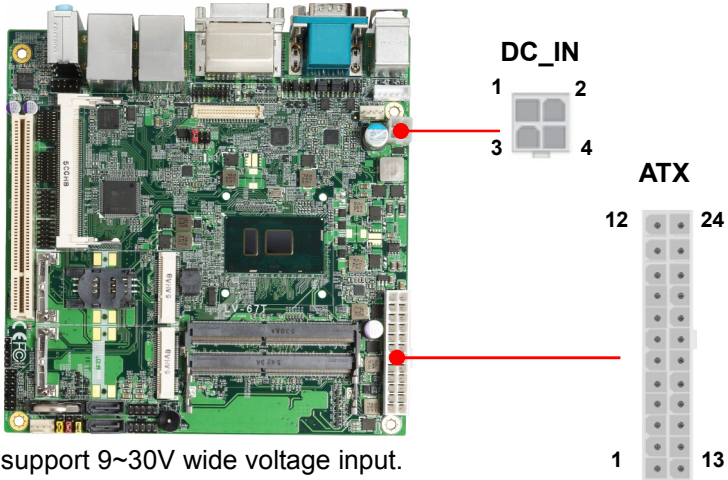

The DC_IN support 9~30V wide voltage input.

Note that the DC_IN and ATX do not use at the same time, it will certainly cause damage.

DC_IN: ATX12V 4-pin connector

Pin	Signal	Pin	Signal
1	GND	2	GND
3	9~30V	4	9~30V

ATX: main power 24-pin connector (As input)

Pin	Signal	Pin	Signal
1	3.3V	13	3.3V
2	3.3V	14	NC
3	GND	15	GND
4	5V	16	-PSON
5	GND	17	GND
6	5V	18	GND
7	GND	19	GND
8	Power_OK	20	NC
9	5VSB	21	5V
10	12V	22	5V
11	12V	23	5V
12	3.3V	24	GND

2.5.2 <Power output>

It is supply to the HDD, CD-ROM or other device.

If using DC_IN as input, that ATX will be the output.

ATX: main power 24-pin connector (As output)

Pin	Signal	Pin	Signal
1	3.3V	13	3.3V
2	3.3V	14	
3	GND	15	GND
4	5V	16	
5	GND	17	GND
6	5V	18	GND
7	GND	19	GND
8		20	
9		21	5V
10	12V	22	5V
11	12V	23	5V
12	3.3V	24	GND

Note that Maximum output power: 12V/2A, 5V/3A, 3.3V/3A

Appendix A <Flash BIOS>

A.1 <Flash tool>

The board is based on Phoenix BIOS and can be updated easily by the BIOS auto flash tool. You can download the tool online at the address below:

[LV-67T reflash tool](#)

The tool's file name is "fpt.exe", it's the utility that can write the data into the BIOS flash chip and update the BIOS.

A.2 <Flash BIOS process>

1. Please make a bootable UFD which can boot into DOS environment.
2. Unzip the flash tool and copy it into bootable UFD.
3. Add a bin file to the same folder..
4. Power on the system and flash the BIOS under the DOS environment.

(Command: fpt -savemac -f xxx.bin)

5. Power off the system and then power on.

Appendix B <Win7 Installation Notes>

B.1 <ME driver> (For 6th gen CPU)

Before installing, it need to install Microsoft Hotfix KB2685611 first for Win7 32/64 bit. More information please refer

<https://www.microsoft.com/en-us/download/details.aspx?id=38423>

B.2 <USB3.0 driver> (For 6th gen CPU)

The Skylake platform removed EHCI host controller, therefore, before install new Win7 OS, need to embed the USB3.0 driver to Win7 installation image file, for more information, please refer Intel document.

Appendix C <LCD Panel Type select>

According to your panel, it needs to select the correct resolution in the BIOS. If there is no fit for your panel type, please provide feedback for us to make an OEM model.

BIOS panel type selection form (BIOS Version:1.0)			
Single / Dual channel		Single / Dual channel	
NO.	Type	NO.	Type
1	640 x 480	9	1680 x 1050
2	800 x 600	10	1920 x 1200
3	1024 x 768	11	1440 x 900
4	1280 x 1024	12	1600 x 900
5	1400 x 1050 Reduced Blanking	13	1024 x 768
6	1400 x 1050 non-Reduced Blanking	14	1280 x 800
7	1600 x 1200	15	1920 x 1080
8	1366 x 768	16	OEM Keep

Appendix D <Programmable GPIO >

The GPIO' can be programmed with the MS-DOS debug program using simple IN/OUT commands.

The DC characteristics please refer to GPIO paragraph (Page20).

GPIO	0	1	2	3	4	5	6	7
bit	0	1	2	3	4	5	6	7

- o 4E 87 ;enter configuration
- o 4E 87
- o 4E 07
- o 4F 07 ;select Logical Device
- o 4E 30
- o 4F 08 ;activate GPIO function (The board use GPIO3)
- o 4E EC
- o 4F XX ;set "01" GPIO as input, set "00" GPIO as output
- o 4E ED
- o 4F XX ;if set GPIO as output, this register's value can be set "00~ FF"

Optional

- o 4E EE
- o 4F XX ;set "01", the respective bit are inverted (Both input and output)
- ;set "00", the respective bit are normal

For further information, please refer to Nuvoton NCT6106D datasheet

Appendix E <Programmable Watch Dog Timer>

Timeout value range

1 to 255 Minute and Second

Program sample

Watchdog timer setup as system reset with 5 second of timeout

```
-o 4E 87      ;enter configuration
-o 4E 87
-o 4E 07
-o 4F 08      ;select Logical Device
-o 4E 30
-o 4F 01      ;activate WDTO# function
-o 4E F0
-o 4F 00      ;set "00" is second mode, set "08" is minute mode
-o 4E F1
-o 4F 05      ;00h: Timeout Disable
                ;01h: Timeout occurs after 1 minute only
                ;02h: Timeout occurs after 2 second/minute
                ;03h: Timeout occurs after 3 second/minute
                ;
                ;FFh: Timeout occurs after 255 second/minute
                (The deviation is approx 1 second.)
```

For further information, please refer to Nuvoton NCT6106D datasheet

Appendix F <SATA RAID function setting>

When use RAID function, it need to enter the BIOS set RAID mode first.

Find the setting from

[Advanced] → [Intel Advanced Menu] → [PCH-IO Configuration]
 → [SATA Configuration] → [SATA Mode Selection]

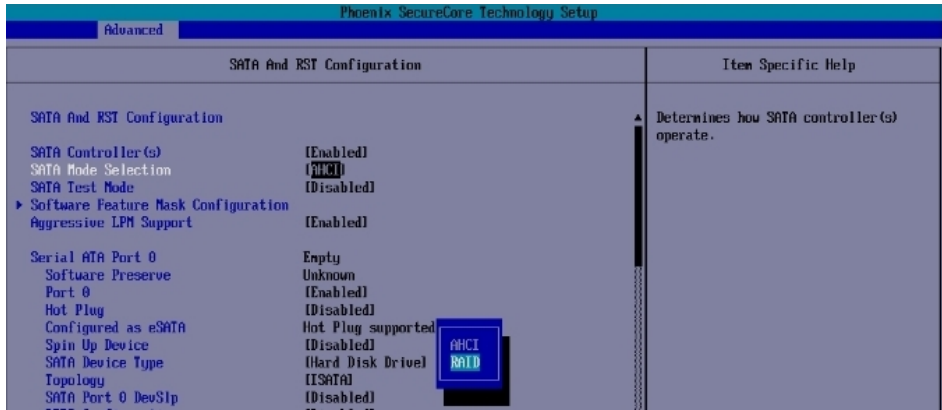

SATA And RST Configuration → Software Feature Mask Configuration

Set Use RST Legacy OROM → [Enable]

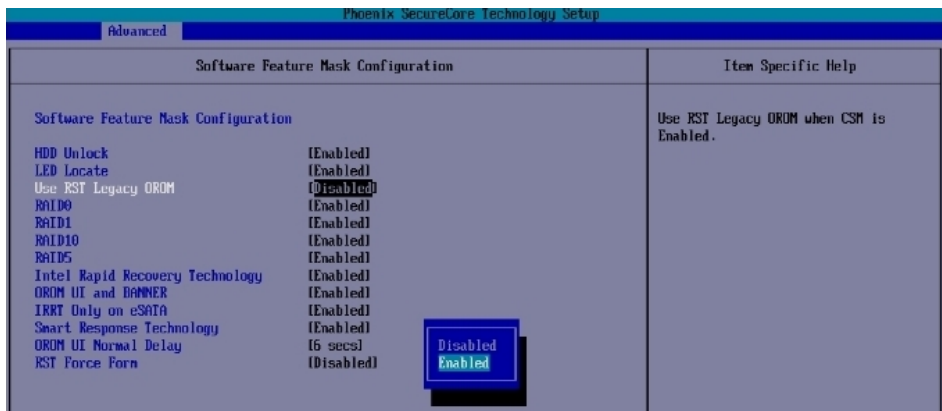

If this screen stop time is too short, it can be set in the BIOS.

- [Advanced] → [Intel Advanced Menu] → [PCH-IO Configuration]
- [SATA Configuration] → [Software Feature Mask Configuration]
- [OROM UI Normal Delay] → [8 sec] **(Need to set RAID mode first)**

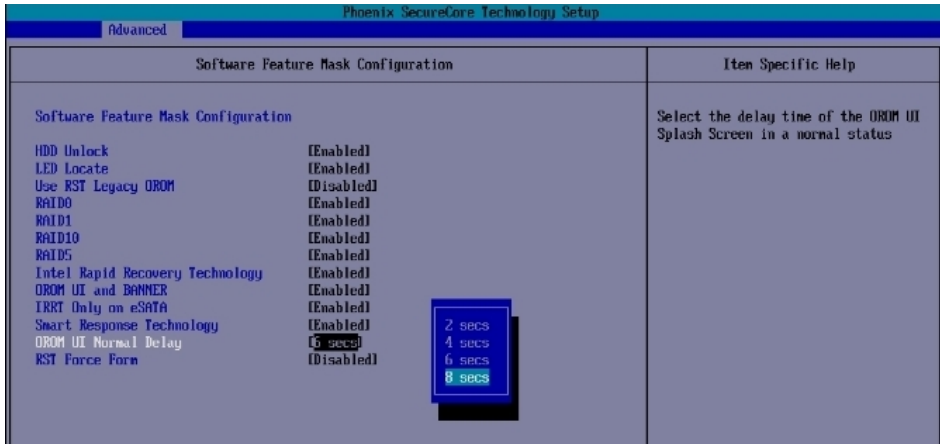

At boot time, press <CTRL + I> to enter the RAID configuration menu.



Contact information

Any advice or comment about our products and service, or anything we can help you please don't hesitate to contact with us. We will do our best to support you for your products, projects and business.

Taiwan Commate computer Inc.

Address	19F., NO.94, Sec. 1, Xintai 5 th Rd., Xizhi Dist., New Taipei City 22102, Taiwan.
TEL	+886-2-26963909
FAX	+886-2-26963911
Website	www.commell.com.tw
E-mail	info@commell.com.tw (General information) tech@commell.com.tw (Technical Support)

Commell is a brand name of Taiwan Commate computer Inc.