

# LV-67A

---

## Mini-ITX motherboard

### User's Manual

Edition: 1.5

2011/9/27



## **Copyright**

Copyright 2009. All rights reserved. This document is copyrighted and all rights are reserved. The information in this document is subject to change without prior notice to make improvements to the products.

This document contains proprietary information and protected by copyright. No part of this document may be reproduced, copied, or translated in any form or any means without prior written permission of the manufacturer.

All trademarks and/or registered trademarks contains in this document are property of their respective owners.

## **Disclaimer**

The company shall not be liable for any incidental or consequential damages resulting from the performance or use of this product.

The company does not issue a warranty of any kind, express or implied, including without limitation implied warranties of merchantability or fitness for a particular purpose.

The company has the right to revise the manual or include changes in the specifications of the product described within it at any time without notice and without obligation to notify any person of such revision or changes.

## **Trademark**

All trademarks are the property of their respective holders.

---

Any questions please visit our website at <http://www.commell.com.tw>.

# Packing List

Please check package component before you use our products.

## Hardware:

LV-67A Mini-ITX motherboard x 1

## Cable Kit:



SATA Cable x 2  
(OALSATA-L)



26-pin Slim Type Floppy Cable x 1  
(OALFD/NB)

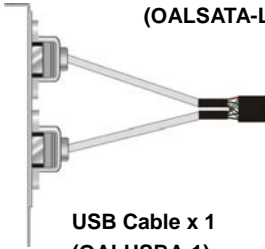

USB Cable x 1  
(OALUSBA-1)

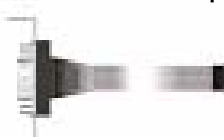

COM Port Cable x 1  
(OAL1S)



VGA Cable x 1 (LV-67AT only)  
(OAL-10PCRT)

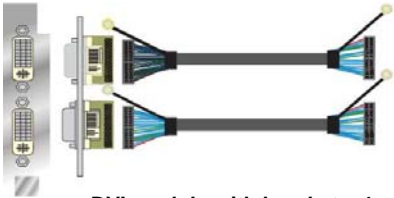

DVI module with bracket x 1  
(BADPDVI2P\_A & OALDVI-P)  
(LV-67AD2 Only)

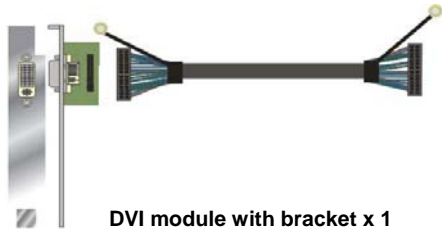

DVI module with bracket x 1  
(BADPDVIP\_A & OALDVI-P)  
(LV-67AD Only)

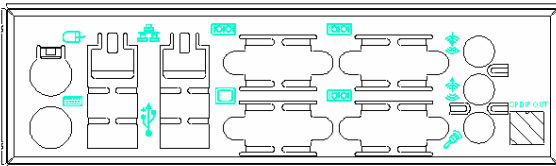

I/O Shield x 1  
(OPLATE-67A)

## Other Accessories:

Divers CD (including User's Manual) x 1

# Index

Chapter1 <Introduction> .....	7
1.1 <Product Overview> .....	7
1.2 <Product Specification> .....	8
1.3 <Block Diagram>.....	10
1.4 <Mechanical Drawing >.....	11
Chapter 2 <Hardware Setup> .....	12
2.1 <Connector Location> .....	12
2.2 <Jumper Reference> .....	13
2.3 <Connector Reference> .....	14
2.3.1 <Internal Connectors> .....	14
2.3.2 <External Connectors>.....	14
2.4 <CPU and Memory Setup> .....	15
2.4.1 <CPU installation> .....	15
2.4.2 <Memory installation> .....	16
2.5 <CMOS Setup> .....	18
2.6 <Serial ATA installation> .....	19
2.7 <Floppy Installation> .....	20
2.8 <LAN installation> .....	21
2.9 <Onboard Display Interface> .....	22
2.9.1 <Analog Display> .....	22
2.9.2 <LVDS Display LV-67AX Only > .....	23
2.9.3 <DVI Display LV-67AD and LV-67AD2> .....	26
2.10 <Audio Installation>.....	27
2.11 <GPIO and SMBUS interface>.....	29
2.12 <USB Installation>.....	30
2.13 <Power and Fan Installation> .....	32
2.14 <Serial Port> .....	34
2.15 <Switch and Indicator>.....	37

Chapter 3 <System Configuration> .....	39
3.1 <SATA configuration> .....	39
3.2 <SATA RAID Configuration> .....	40
3.3 <Audio Configuration> .....	44
3.4 <Video Memory Setup> .....	45
3.5 <Display Properties Setting>.....	47
Chapter 4 <BIOS Setup> .....	49
Appendix A <I/O Port Pin Assignment> .....	51
A.1 <Serial ATA Port> .....	51
A.2<Floppy Port> .....	51
A.3 <IrDA Port> .....	52
A.5 <VGA Port>.....	53
A.6 <LAN Port> .....	53
Appedix B <System Resources> .....	54
B.1 <I/O Port Address Map> .....	54
B.2 <Memory Address Map>.....	56
B.3 <System IRQ Resources> .....	57
Appedix C <Flash BIOS>.....	58
C.1 <BIOS Auto Flash Tool> .....	58
C.2 <Flash Method>.....	58
Appendix D <Programming GPIO's> .....	59
Appendix E <Watch Dog timer Setting > .....	60
Contact Information.....	61

**(This Page is Left for Blank)**

## **Chapter1 <Introduction>**

### **1.1 <Product Overview>**

**LV-67A** is the motherboard with last Intel desktop technology with Mini-ITX form factor. Based on Intel® Q45 and ICH10DO, the board integrates a new Core 2 Quad / Core 2 Duo Celeron processor 775-pin socket, DDR3 memory socket, Intel® Graphic Media Accelerator 4500 technology, Serial ATA II with RAID function for a powerful desktop system.

#### **Intel® LGA775 processor**

The Intel® Core 2 Quad / Core 2 Duo / Celeron processor now comes with a new form factor with 775-pin PLGA package, for 800/1066/1333MHz front-side-bus, 12MB L2 cache, for 65nm and 45nm manufacturing technology, the PLGA processor without pin header on solder side can make user installing the processor on the socket easier.

#### **Intel® Q45 and ICH10DO chipset**

The Intel Q45 integrates DDR3 800/1066MHz for memory, and Graphic Media Accelerator (GMA) 4500 technology for new graphic engine. It can provide up to 1024MB of frame buffer when you install over 1GB of system memory. The ICH10DO integrates with up to 8 USB2.0 interfaces, and serial ATA II interface with RAID function.

#### **Flexible Extension Interface**

The board provides one PCI-slot for graphics card, it also can support PCI-slot for LAN card or other devices. The board also provides mini-PCI socket.

## 1.2 <Product Specification>

### General Specification

Form Factor	Mini-ITX motherboard
CPU	Intel® Core 2 Quad / Core 2 Duo / Celeron processor With <b>LGA775</b> socket Package type: PLGA 775 Front side bus: 800/1066/1333MHZ (200/266/333MHZ x 4)
Memory	2 x 240-pin DDR3 800/1066MHZ SDRAM up to 4GB Unbuffered, none-ECC memory supported only
Chipset	Intel® Q45 (Northbridge) and ICH10DO (Southbridge)
BIOS	Phoenix-Award v6.00PG 8Mb SPI flash BIOS
Green Function	Power saving mode includes doze, standby and suspend modes. ACPI version 1.0 and APM version 1.2 compliant
Watchdog Timer	System reset programmable watchdog timer with 1 ~ 255 sec./min. of timeout value
Real Time Clock	Intel® ICH10DO built-in RTC with lithium battery
Serial ATAII	Intel® ICH10DO integrates 6 Serial ATA II interface RAID 0, 1,5,10 Intel Matrix Storage Technology supported

### Multi-I/O Port

Chipset	Intel® 82801HDO( ICH10DO) with Winbond® W83627DHG Controller
Serial Port	Three RS-232 and one RS232/422/485 serial ports
USB Port	Eight Hi-Speed USB 2.0 ports with 480Mbps of transfer rate
Floppy Port	One slim type Floppy port
IrDA Port	One IrDA compliant Infrared interface supports SIR
K/B & Mouse	External PS/2 keyboard and mouse ports on rear I/O panel
GPIO	One 12-pin Digital I/O connector with 8-bit programmable I/O Interface
Smart Fan	One CPU fan connectors for fan speed controllable

### VGA Display Interface

Chipset	Intel® Q45 GMA4500 (Graphic Memory Controller Hub)
Frame Buffer	Up to 1024MB shared with system memory
Display Type	CRT, LCD monitor with analog display Onboard 18/24-bit dual channel LVDS interface ( <b>LV-67AX</b> ) Onboard DVI interface ( <b>LV-67AD/LV-67AD2</b> ) Optional Secondary CRT Connector ( <b>LV-67AT</b> )
Connector	External DB15 female connector on rear I/O panel Onboard 40-pin LVDS connector ( <b>LV-67AX</b> ) Onboard 26-pin DVI Connector ( <b>LV-67AD/L-67AD2</b> ) Onboard 10-pin CRT2 Connector ( <b>LV-67AT</b> )



## LV-67A User's Manual

### Ethernet Interface

Controller	Two Intel 82574L Gigabit Ethernet controller
Type	Triple speed 10/100/1000Base-T Auto-switching Fast Ethernet Full duplex, IEEE802.3U compliant
Connector	Two External RJ45 connectors with LED on rear I/O panel

### Audio Interface

Chipset	Intel® ICH10DO with Realtek ALC888HD Audio Intel High Definition Audio compliance
Interface	2 channels sound output
Connector	External 3 phone jack for 2 channel audio on rear I/O panel External SPDIF connector on rear I/O panel Internal 10-pin header for line-out, MIC-in, 4-pin header for CD-IN

### Expansive Interface

Mini PCI	One Mini-PCI socket <b>TYPE III A</b> (32-bit, 33MHz) Power supply: +3.3V, +5V
----------	---

### Power and Environment

Power Requirement	Standard ATX <b>24-pin (20-pin is compatible)</b> power supply Additional +12V 4-pin power connector
Dimension	170 (L) x 170 (H) mm
Temperature	Operating within 0 ~ 60°C (32 ~ 140°F) Storage within -20 ~ 85°C (-4 ~ 185°F)

### Ordering Code

<b>LV-67AD</b>	Onboard VGA, 2 x Intel® Gigabit LAN, 8 x USB2.0, Mini-PCI PCI, 4 x serial Port, 1 x FDD, Realtek ALC888 HD Audio 6 x SATA, 1 x IrDA, <b>1x DVI Interface</b>
<b>LV-67AD2</b>	Same as LV-67AD with <b>secondary DVI</b> Interface
<b>LV-67AX</b>	Same as LV-67AD with 18/24-bits <b>LVDS</b> instead of DVI
<b>LV-67AT</b>	Same as LV-67AD with <b>secondary CRT</b> instead of DVI

The specifications may be different as the actual production.

### 1.3 <Block Diagram>

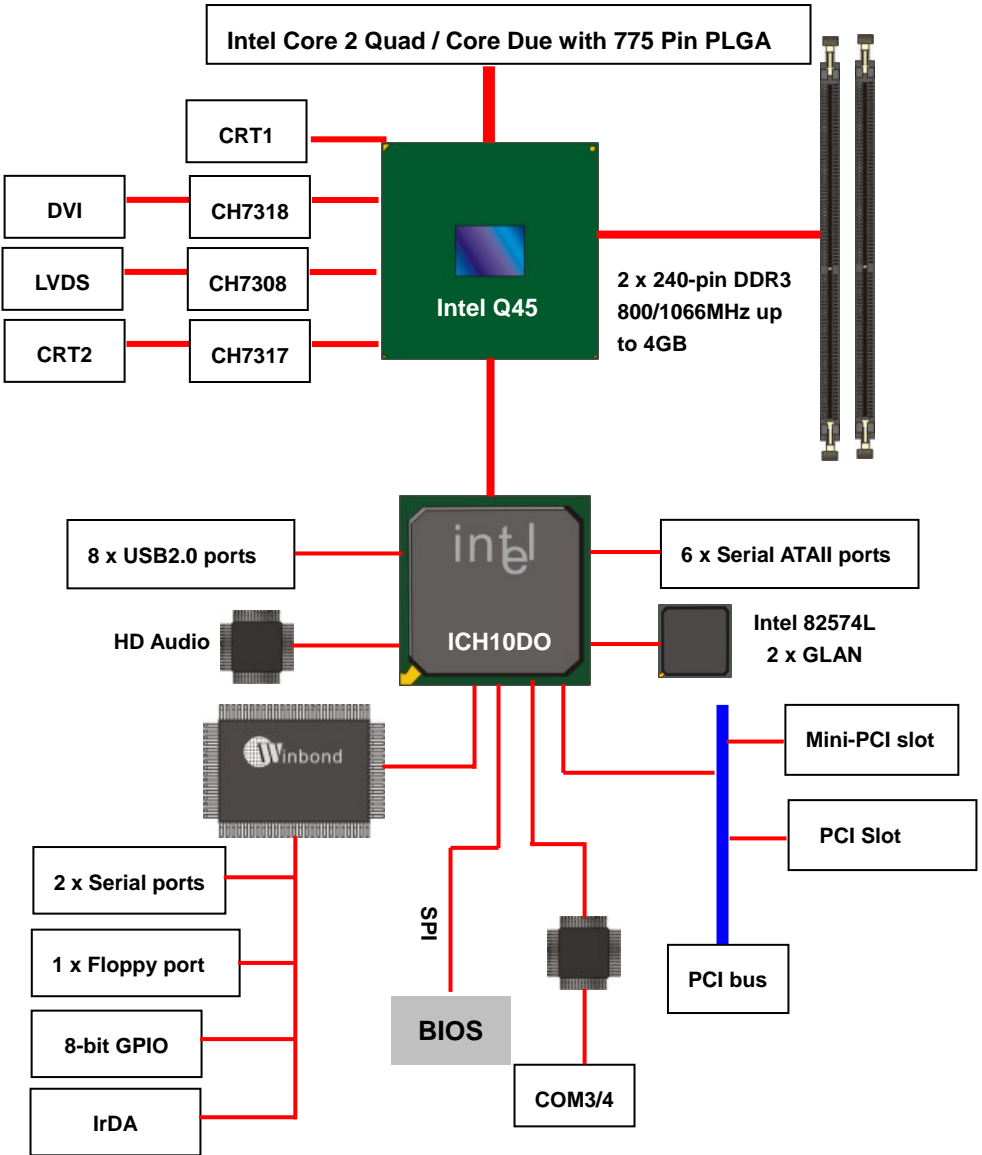

1.4 <Mechanical Drawing >

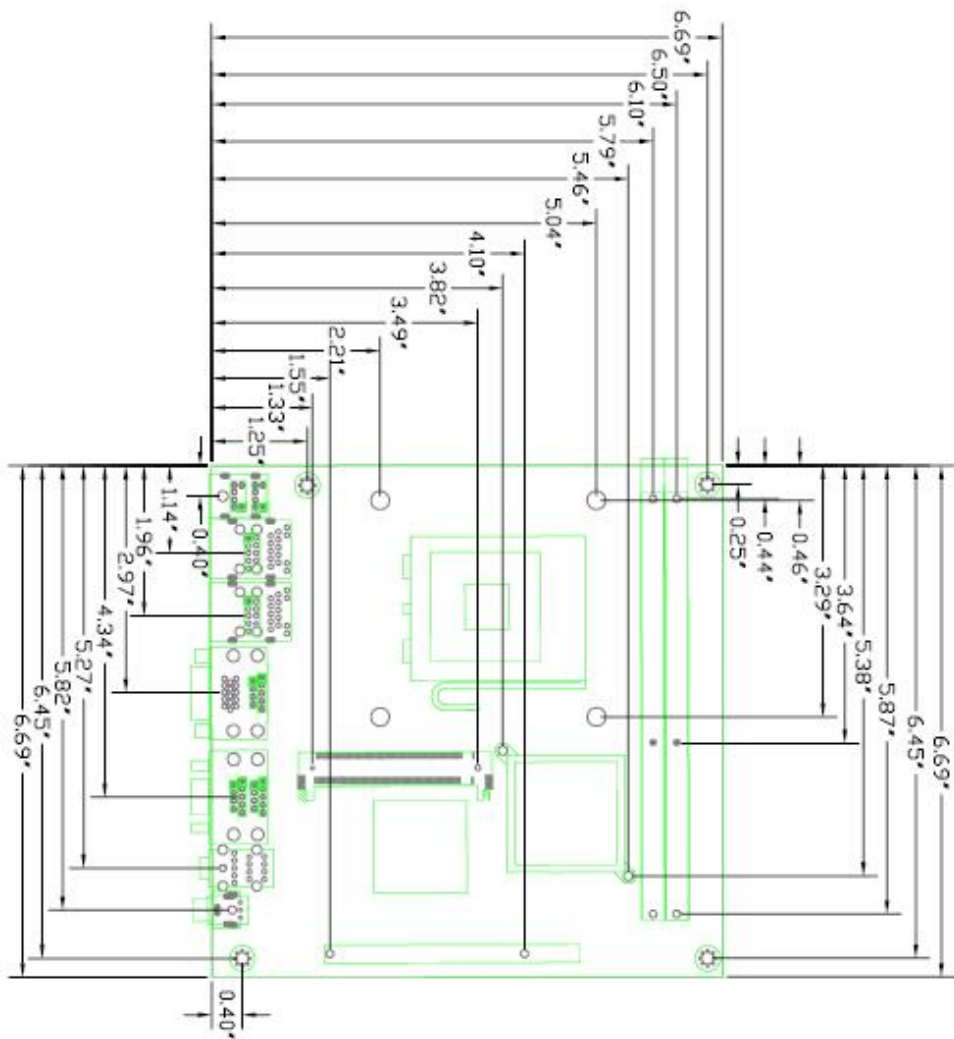

Unit: inch

# Chapter 2 <Hardware Setup>

## 2.1 <Connector Location>

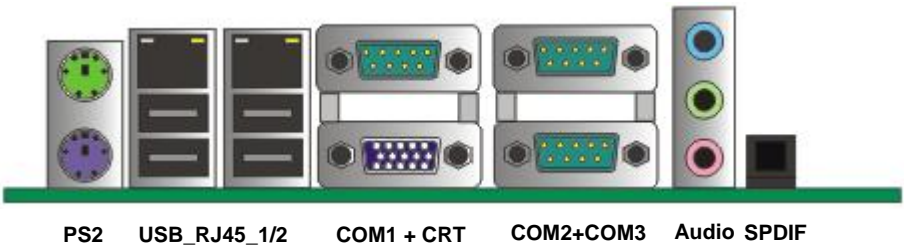
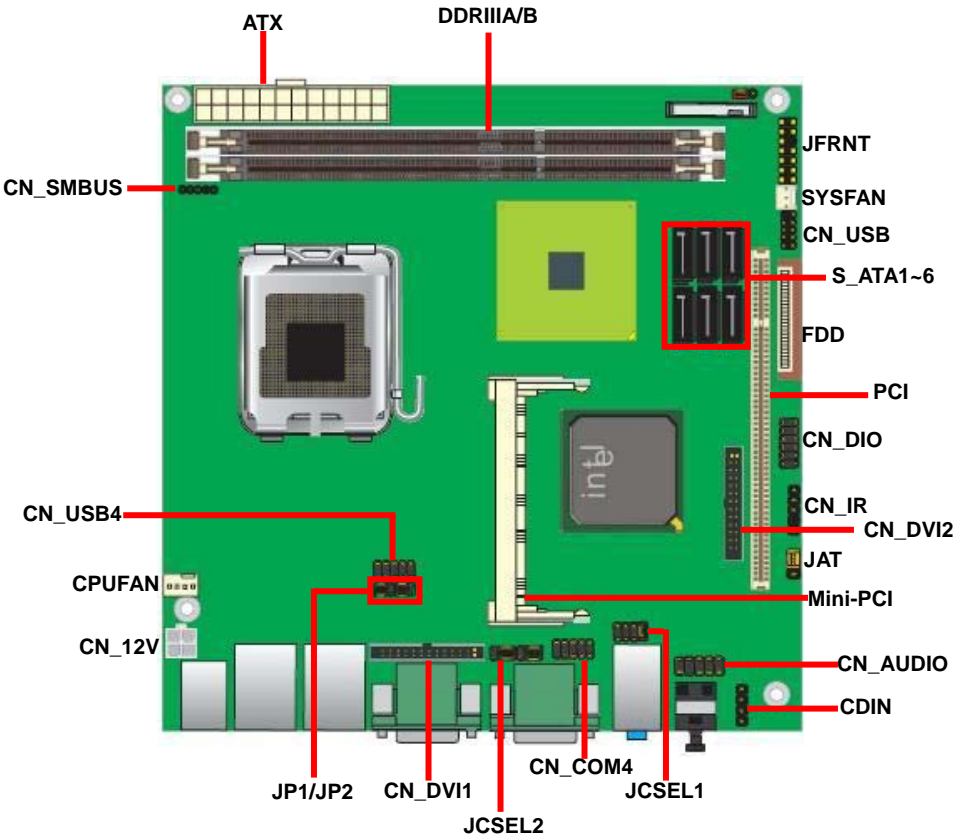

## 2.2 <Jumper Reference>

Jumper	Function
JRTC	CMOS Operating/Clear Setting
JVLCD	Panel Voltage Setting (LV-67AX)
JP1	COM1 signal mode switch (For Pin-1 & Pin-9)
JP2	COM2 signal mode switch (For Pin-1 & Pin-9)
JAT	Power mode select
JCSEL1	CN_COM2 RS-232 RS422 RS485 Setting
JCSEL2	CN_IR IrDA Setting

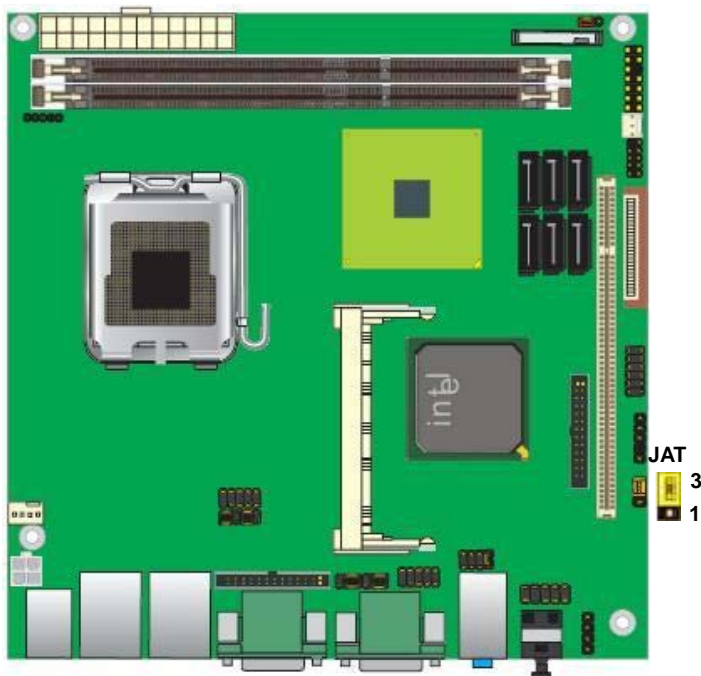

Jumper: JAT

Type: Onboard 3-pin jumper

JAT	Mode
1-2	AT Power mode
2-3	ATX Power mode
Default setting	

## 2.3 <Connector Reference>

### 2.3.1 <Internal Connectors>

Connector	Function	Remark
CPU	LGA775 CPU socket	
DDRIII1/2	240 –pin DDR2 SDRAM DIMM socket	
FDD	26-pin slim type floppy connector	
S_ATAII1/2/3/4/5/6	7-pin Serial ATA II connector	
ATX	24-pin power supply connector	
CN_12V	4-pin +12V additional power supply connector	
CN_AUDIO	5 x 2-pin audio connector	
CDIN	4-pin CD-ROM audio input connector	
CN_DIO	6 x 2-pin digital I/O connector	
CN_USB1/4	10-pin USB connector	
CPUFAN	4-pin CPU cooler fan connector	
SYSFAN	3-pin system cooler fan connector	
NBFAN	3-pin Northbridge cooler fan connector	
CN_IR	5-pin IrDA connector	
CN_SMBUS	5-pin SMBUS connector	
CN_INV	5-pin LCD inverter connector	<b>LV-67AX</b>
CN_LVDS	20 x 2-pin LVDS connector	<b>LV-67AX</b>
JFRNT	14-pin front panel switch/indicator connector	
PCI1	120-Pin PCI socket	
Mini-PCI	1 x Mini-PCI socket	
CN_DVI1	26-Smd Pin connector	<b>LV-67AD</b>
CN_DVI2	26-Pin connector	<b>LV-67AD2</b>
CN_CRT	10-Pin connector	<b>LV-67AT</b>
CN_COM2	5 x 2-pin com connector	

### 2.3.2 <External Connectors>

Connector	Function	Remark
PS2	PS/2 Keyboard/Mouse connector	
CRT+COM1	DB15 VGA + Serial port connector	
USB_RJ45_1/2	Dual USB and one RJ45 LAN Port	
COM 2/3	Serial port connector	
AUDIO	Audio connectors	
SPDIF	SPDIF digital audio output connector	

## 2.4 <CPU and Memory Setup>

### 2.4.1 <CPU installation>

LV-67A has a LGA775 CPU socket onboard; please check following steps to install the processor properly.

**Attention** If LV-67A need RMA please Keep CPU socket cover on the CPU Socket.

**Warning** If CPU Socket internal Pin damage We could not provide warranty.



Intel® Quad Core 2 Quad / Core 2 Duo  
Celeron processor  
Package type: 775 pin PLGA  
FSB:/800/1066/1333MHz  
Manufacturing: 65nm / 45nm  
Intel Hyper Threading Technology and  
Core 2 Duo Quad / Duo supported

1. Lift this bar

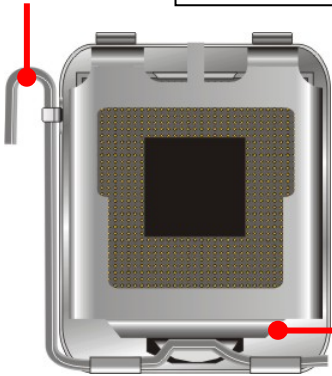

2. Uncover this plate

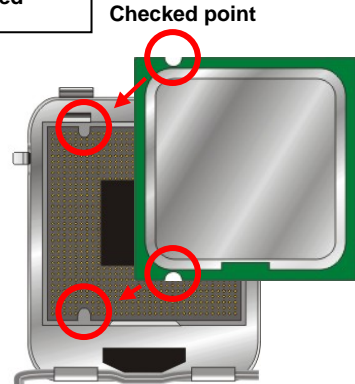

3. Place the CPU on the top of the pins

4. Lock this bar

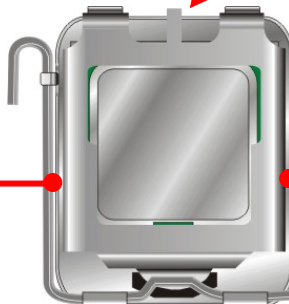

3. Cover this plate

**Notice:** Please place the CPU on the pins tenderly to avoid bending the pins

## 2.4.2 <Memory installation>

LV-67A has two 240-pin DDR3 DIMM support up to 4GB of memory capacity. The memory frequency supports 800/1066 MHz. Only Non-ECC memory is supported.

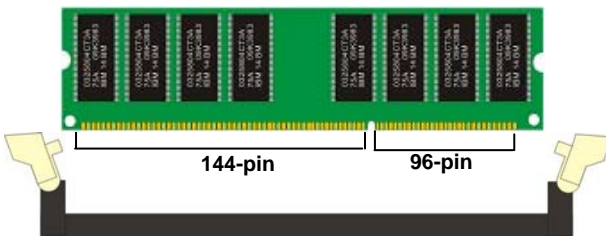
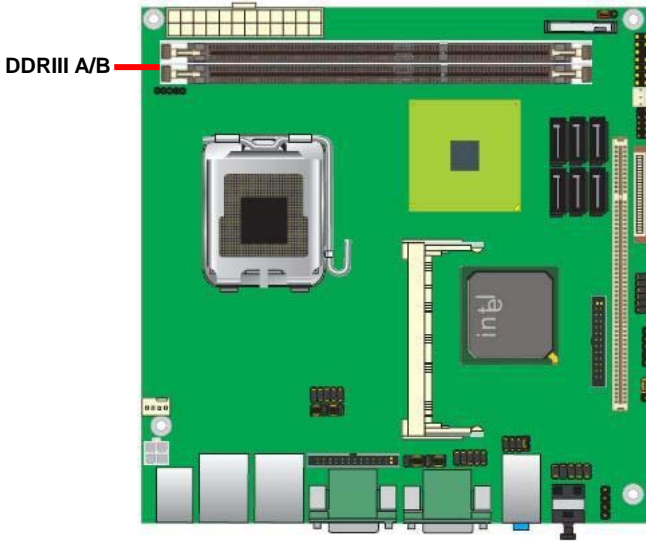

Please check the pin number to match the socket side well before installing memory module.



**Supported DIMM Module Configurations**

Memory Type	Raw Card Version	DIMM Capacity	DRAM Device Technology	DRAM Organization	# of DRAM Devices	# of Physical Device Ranks	# of Row/ Col Address Bits	# of Banks Inside DRAM	Page Size
DDR3 800 and 1066	A	512 MB	512Mb	64M X 8	8	1	13/10	8	8K
		1 GB	1Gb	128M X 8	8	1	14/10	8	8K
	B	1 GB	512Mb	64M X 8	16	2	13/10	8	8K
		2 GB	1Gb	128M X 8	16	2	14/10	8	8K
	C	256 MB	512Mb	32M X 16	4	1	12/10	8	8K
		512 MB	1Gb	64M X 16	4	1	13/10	8	8K
	F	512 MB	512Mb	32M X 16	8	2	12/10	8	8K
		1 GB	1Gb	64M X 16	8	2	13/10	8	8K

## 2.5 <CMOS Setup>

The board's data of CMOS can be setting in BIOS. If the board refuses to boot due to inappropriate CMOS settings, here is how to proceed to clear (reset) the CMOS to its default values.

**Jumper: JRTC**

**Type: Onboard 3-pin jumper**

JRTC	Mode
1-2	Clear CMOS
2-3	Normal Operation

Default setting

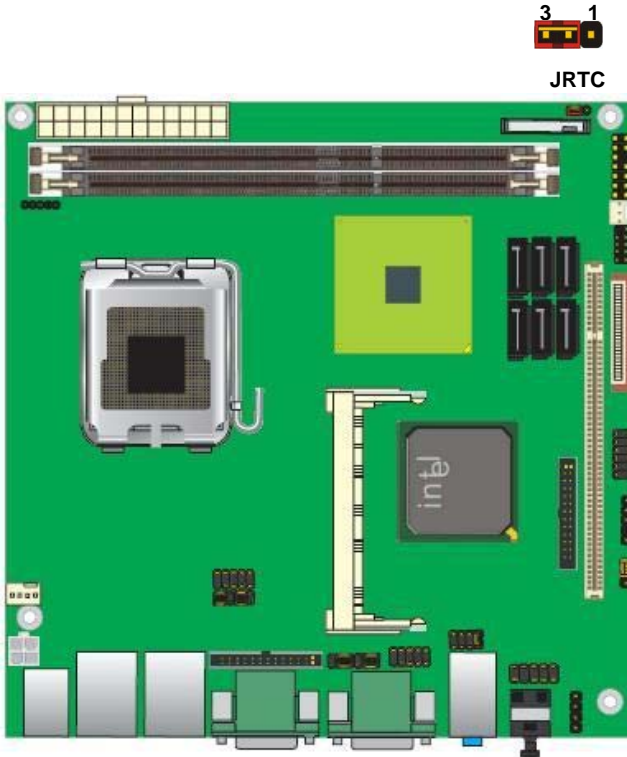

## 2.6 <Serial ATA installation>

LV-67A has Six Serial ATA II interfaces with RAID function, the transfer rate of the Serial ATA II can be up to 300MB/s. Please go to <http://www.serialata.org/> for more about Serial ATA technology information. Based on Intel® ICH10DO, it supports **Intel® Matrix Storage Technology** with combination of RAID 0,1,5 and 10. The main features of RAID on ICH10DO are listed below:

1. Supports for up to RAID volumes on a single, two-hard drive RAID array.
2. Supports for two, two-hard drive RAID arrays on any of six Serial ATA ports.
3. Supports for Serial ATA ATAPI devices.
4. Supports for RAID spares and automatic rebuild.
5. Supports on RAID arrays, including NCQ and native hot plug.

*For more information please visit Intel's official website.*

For more about the system setup for Serial ATA, please check the chapter of SATA configuration.

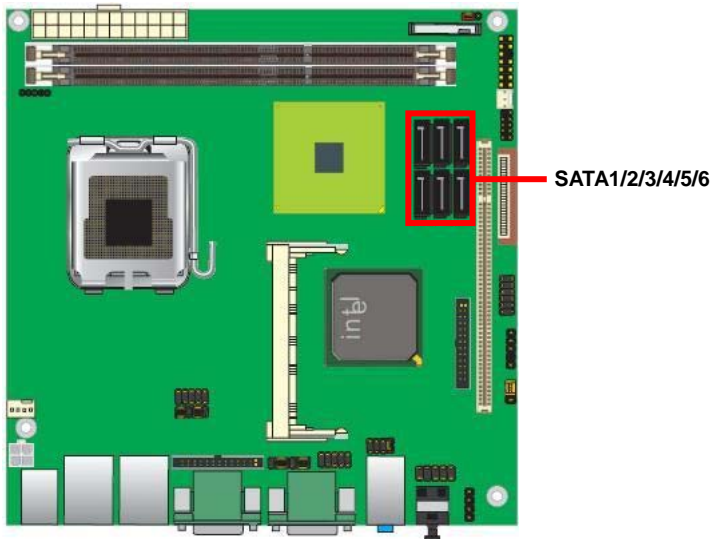

## 2.7 <Floppy Installation>

LV-67A has one slim type 26-pin floppy interface, it supports notebook use floppy and powering from onboard, please follow up the steps below to install the device.

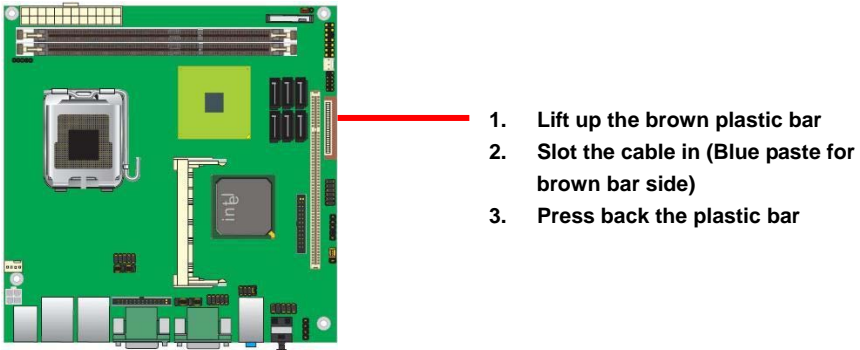
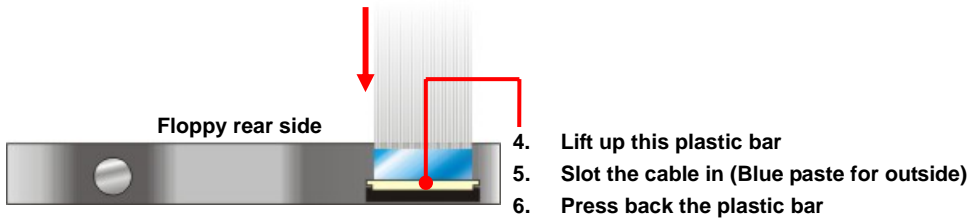
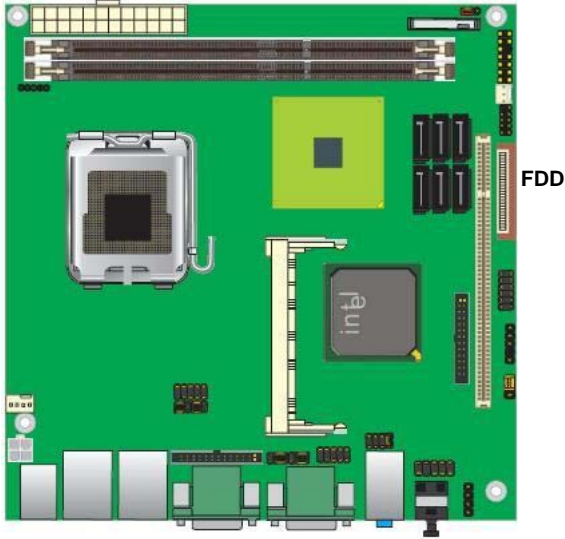

## 2.8 <LAN installation>

The board integrates with two Intel 82574L Gigabit Ethernet controllers, as the PCI Express bus. The Intel 82574L supports triple speed of 10/100/1000Base-T, with IEEE802.3 compliance and Wake-On-LAN supported.

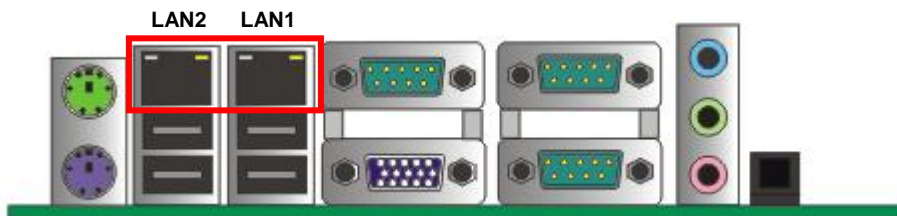

## 2.9 <Onboard Display Interface>

Based on Intel Q45 chipset with built-in graphics, the board provides one DB15 Connector on rear external I/O port, or optional Secondary CRT connector (LV-67AT) and One 40-pin LVDS interface with 5-pin LCD backlight inverter connector. (LV-67AX)

The board also provides 26-pin DVI interface (LV-67AD) or two DVI interface (LV-67AD2)

*Notice: When you install any PCI Graphic card, the onboard graphics would be disabled automatically.*

### 2.9.1 <Analog Display>

Please connect your CRT or LCD monitor with DB15 male connector to the onboard DB15 female connector on rear I/O port or optional Secondary CRT connector Dip 10 Pin (LV-67AT)

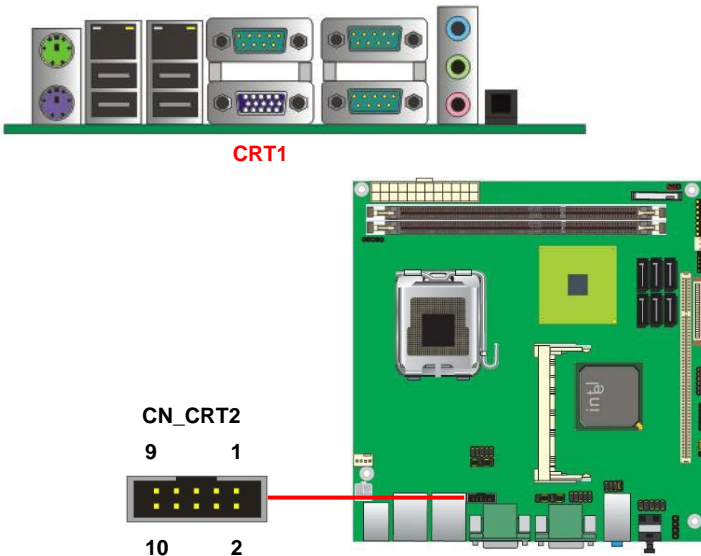

Connector: **CN\_CRT2**

Type: onboard 10-pin connector for CRT2 (Pitch = 2.00 mm)

Pin	Signal	Pin	Signal
2	CRT2 DDC_DA	1	CRT2 DDC_DC
4	CRT2 R	3	GND
6	CRT2 G	5	CRT2 B
8	CRT2 HSYNC	7	CRT2 VSYNC
10	GND	9	GND

2.9.2 <LVDS Display LV-67AX Only >

The board provides one 40-pin LVDS connector for 18/24-bit dual channel panels, supports up to 1600 x 1200 (UXGA) of resolution, with one LCD backlight inverter connector and one jumper for panel voltage setting.

**Warning :**

**Default settings of resolution is 1024 x 768, please offer us panel's datasheet to make OEM BIOS with customized made resolution.**

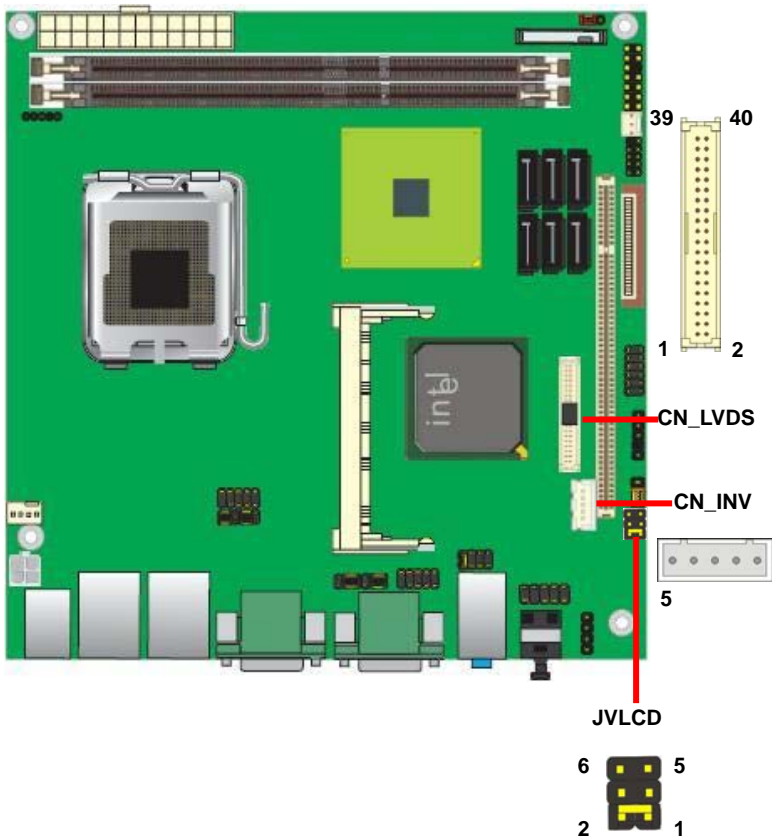

Connector: **CN\_INV**

Type: 5-pin LVDS Power Header

Pin	Description
1	+12V
2	GND
3	GND
4	GND
5	ENABKL

Connector: **JVLCD**

Type: 6-pin Power select Header

Pin	Description
1-2	LCDVCC ( <b>3.3V</b> )
3-4	LCDVCC ( <b>5V</b> )
5-6	LCDVCC ( <b>12V</b> )

Default setting: 1-2

Connector: **CN\_LVDS**

Type: onboard 40-pin connector for LVDS connector

Connector model: **HIROSE DF13-40DP-1.25V**

Pin	Signal	Pin	Signal
2	LCDVCC	1	LCDVCC
4	GND	3	GND
6	ATX0-	5	BTX0-
8	ATX0+	7	BTX0+
10	GND	9	GND
12	ATX1-	11	BTX1-
14	ATX1+	13	BTX1+
16	GND	15	GND
18	ATX2-	17	BTX2-
20	ATX2+	19	BTX2+
22	GND	21	GND
24	ACLK-	23	BTX3-
26	ACLK+	25	BTX3+
28	GND	27	GND
30	ATX3-	29	BCLK-
32	ATX3+	31	BCLK+
34	GND	33	GND
36	N/C	35	N/C
38	N/C	37	N/C
40	N/C	39	N/C



## LV-67A User's Manual

---

To setup the LCD, you need the component below:

1. A panel with LVDS interfaces.
2. An inverter for panel's backlight power.
3. A LCD cable and an inverter cable.

For the cables, please follow the pin assignment of the connector to make a cable, because every panel has its own pin assignment, so we do not provide a standard cable; please find a local cable manufacture to make cables.

### LCD Installation Guide:

1. Preparing the **LV-67AX**, **LCD panel** and the **backlight inverter**.

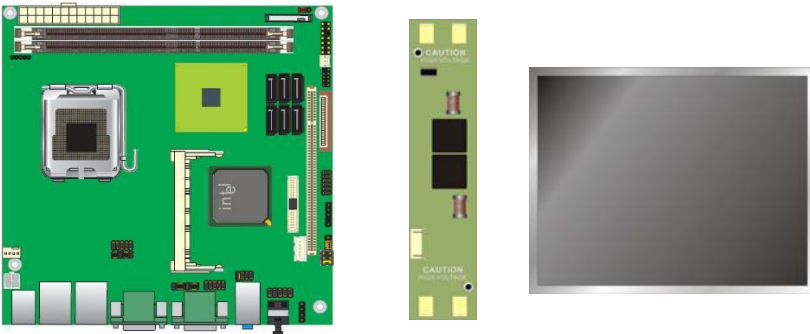

2. Please check the datasheet of the panel to see the voltage of the panel, and set the jumper **JVLCD** to +5V +3.3V and 12V.
3. You would need a LVDS type cable.



4. To connect all of the devices well.

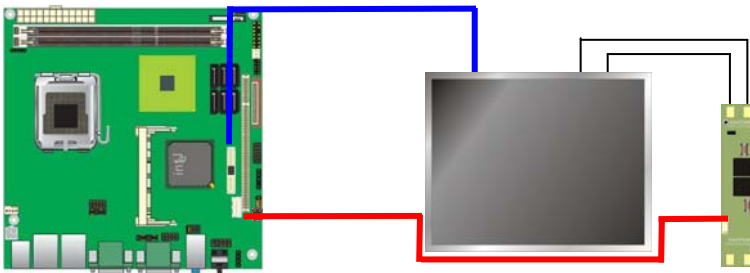

### 2.9.3 <DVI Display LV-67AD and LV-67AD2>

The board provides optional DVI1-D (LV-67AD) and two DVI (LV-67AD2) interfaces with Intel Q45, compliant with DVI 1.0 standard.

Connector: **CN\_DVI1, CN\_DVI2**

Connector type: 26-pin header connector (pitch = 2.00mm)

Pin Number	Assignment	Pin Number	Assignment
1	TX1+	2	TX1-
3	Ground	4	Ground
5	TXC+	6	TXC-
7	Ground	8	PVDD
9	N/C	10	N/C
11	TX2+	12	TX2-
13	Ground	14	Ground
15	TX0+	16	TX0-
17	N/C	18	HPDET
19	DDCDATA	20	DDCCLK
21	GND	22	N/C
23	N/C	24	N/C
25	N/C	26	N/C

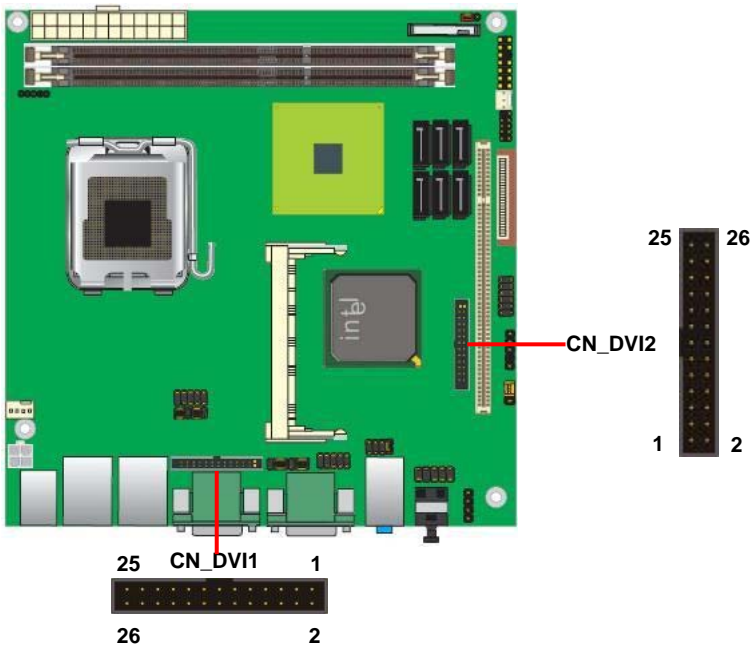

## 2.10 <Audio Installation>

The board integrates onboard audio interface with REALTEK ALC888 codec, with Intel next generation of audio standard as High Definition Audio, it offers more vivid sound and other advantages than former HD audio compliance.

The main specifications of ALC888 are:

- **High-performance DACs with 100dB S/N ratio**
- **2 DAC channels support 16/20/24-bit PCM format for 2 audio solution**
- **16/20/24-bit S/PDIF-OUT supports 44.1K/48K/96kHz sample rate**
- **Compatible with HD**
- **Meets Microsoft WHQL/WLP 2.0 audio requirements**

The board provides 2 channels audio phone jacks on rear I/O port, Line-in/MIC-in ports for front I/O panel through optional cable.

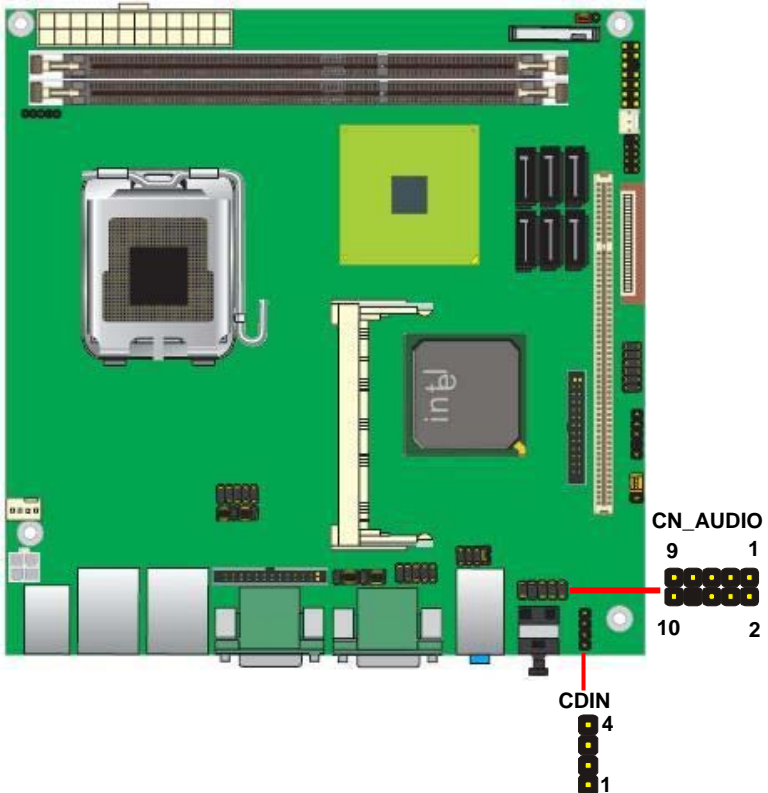

**Connector: CN\_AUDIO**

Type: 10-pin (2 x 5) header (pitch = 2.54mm)

Pin	Description	Pin	Description
1	MIC_L	2	Ground
3	MIC_R	4	ACZ_DET
5	Speaker_R	6	MIC Detect
7	SENSE	8	N/C
9	Speaker_L	10	Speaker Detect

**Connector: CDIN**

Type: 4-pin header (pitch = 2.54mm)

Pin	Description
1	CD – Left
2	Ground
3	Ground
4	CD – Right

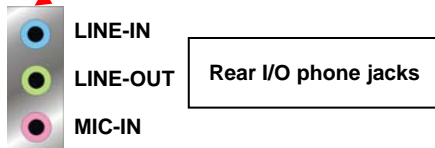
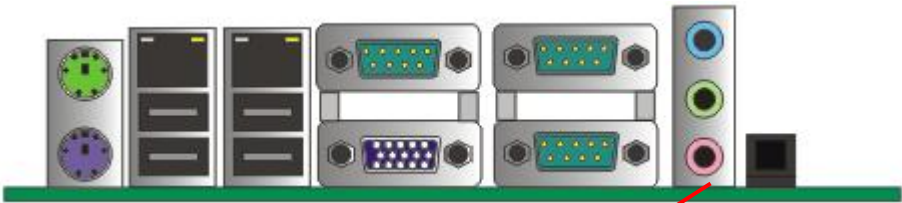

## 2.11 <GPIO and SMBUS interface>

The board provides a programmable 8-bit digital I/O interface, and a SMBUS (System management bus) interface for control panel application.

Connector: **CN\_DIO**

Type: onboard 2 x 6-pin header, pitch=2.0mm

Pin	Description	Pin	Description
1	Ground	2	Ground
3	GP10	4	GP14
5	GP11	6	GP15
7	GP12	8	GP16
9	GP13	10	GP17
11	VCC	12	+12V

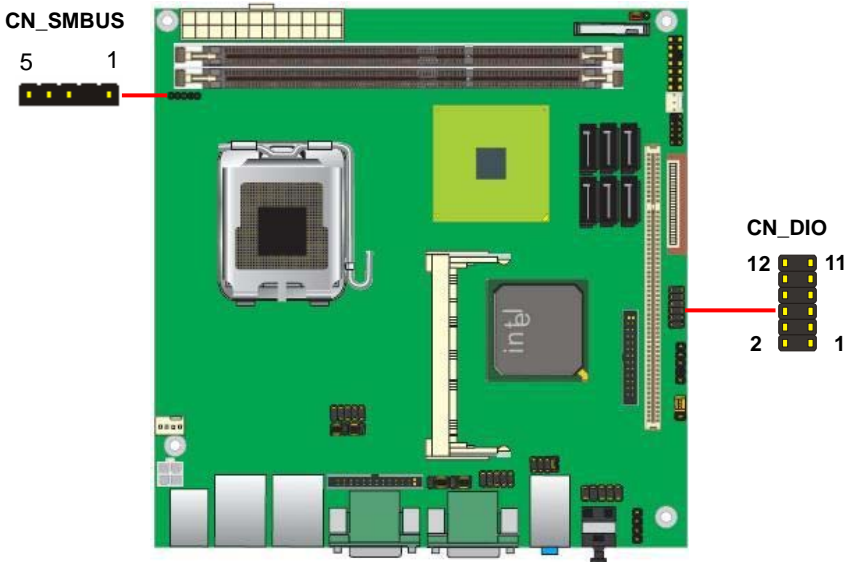

Connector: **CN\_SMBUS**

Type: 5-pin header for SMBUS Ports

Pin	Description
1	VCC
2	N/C
3	SMBDATA
4	SMBCLK
5	Ground

## 2.12 <USB Installation>

LV-67A integrates eight USB2.0 ports. The specifications of USB2.0 are listed below:

Interface	USB2.0
Controller	Intel ICH10DO
Transfer Rate	Up to 480Mb/s
Voltage	5V

The Intel® ICH10DO contains two Enhanced Host Controller Interface (EHCI) and five Universal Host Controller Interfaces (UHCI), it can determine whether your connected device is for USB1.1 or USB2.0, and change the transfer rate automatically.

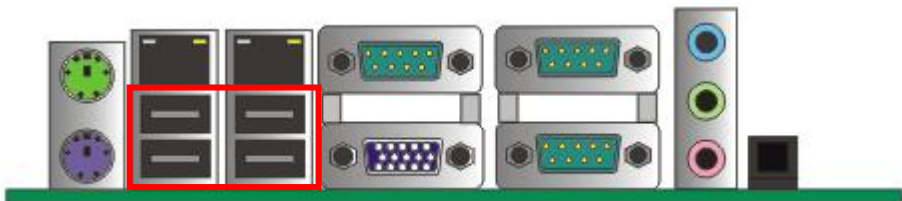

USB3/4/5/6

Connector: **CN\_USB**

Type: 10-pin (5 x 2) header for USB5/6 Ports

Pin	Description	Pin	Description
1	VCC	2	VCC
3	Data0-	4	Data1-
5	Data0+	6	Data1+
7	Ground	8	Ground
9	Ground	10	N/C

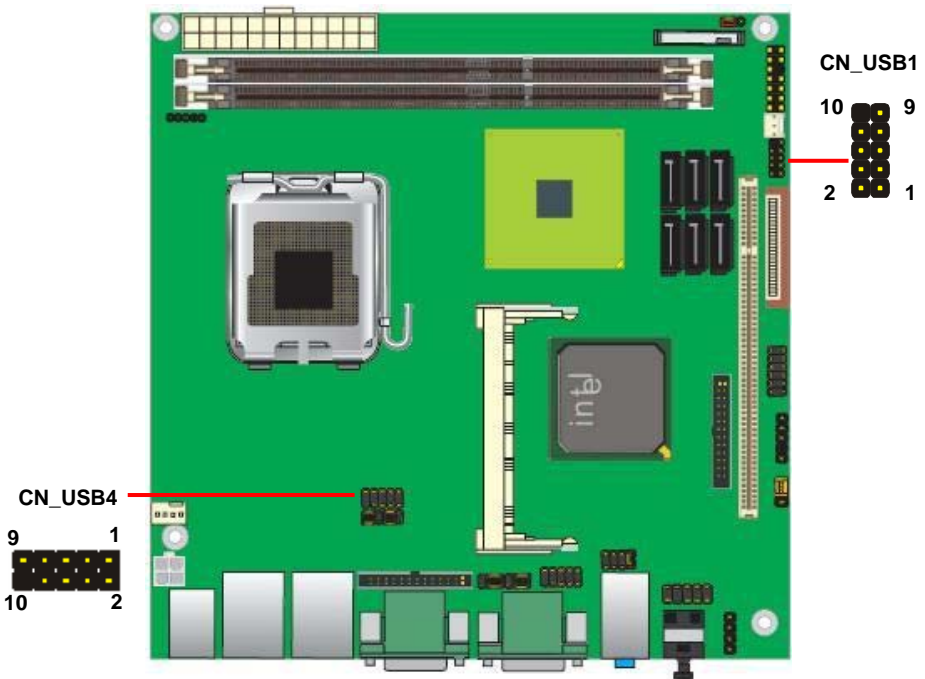

## 2.13 <Power and Fan Installation>

The LV-67A provides a standard ATX power supply with **24-pin** ATX connector and additional 12V connector, and the board provides one **4-pin** fan connectors supporting smart fan for CPU cooler and one 3-pin cooler fan connectors for system and Northbridge chip. The 4-pin CN\_12V additional power connector is necessary for CPU powering; please connect this well before you finishing the system setup.

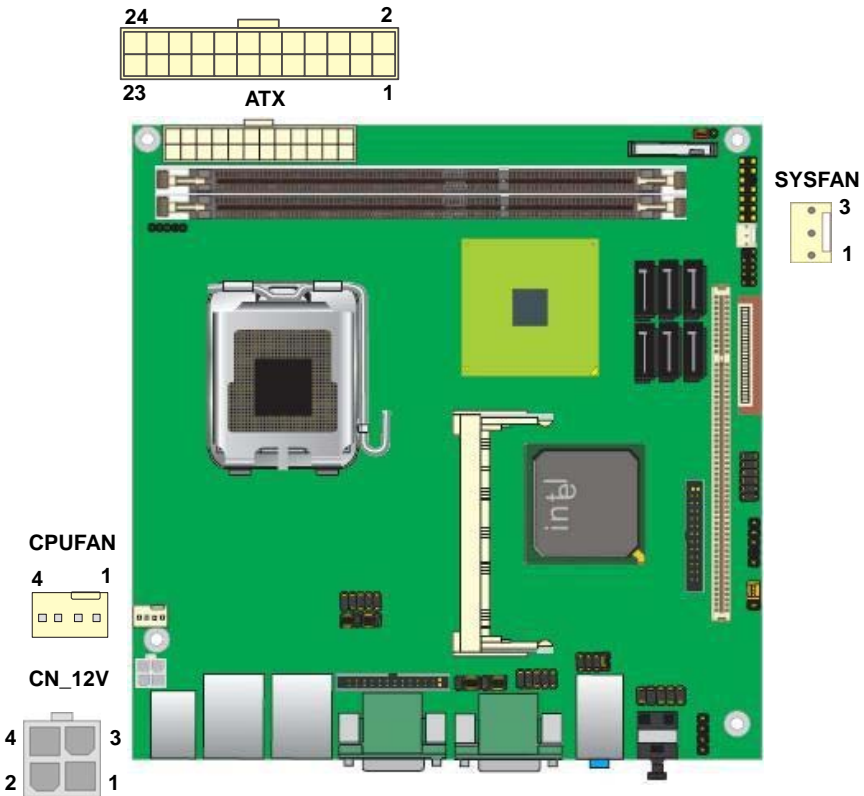



Connector: **ATX**

Type: 24-pin ATX power connector

PIN assignment			
1	3.3V	13	3.3V
2	3.3V	14	-12V
3	GND	15	GND
4	5V	16	PS_ON
5	GND	17	GND
6	5V	18	GND
7	GND	19	GND
8	PW_OK	20	-5V
9	5V_SB	21	5V
10	12V	22	5V
11	12V	23	5V
12	3.3V	24	GND

Connector: **CN\_12V**

Type: 4-pin standard Pentium 4 additional +12V power connector

Pin	Description	Pin	Description
1	Ground	2	Ground
3	+12V	4	+12V

Connector: **CPUFAN**

Type: 4-pin fan wafer connector

Pin	Description	Pin	Description
1	Ground	2	+12V
3	Fan Speed Detection	4	Fan Control

Connector: **SYSFAN**

Type: 3-pin fan wafer connector

Pin	Description	Pin	Description	Pin	Description
1	Ground	2	+12V	3	Sense

## 2.14 <Serial Port>

The board supports Three RS232 serial port and one jumper selectable RS232/422/485 serial ports. The jumper JCSEL1 & JCSEL2 can let you configure the communicating modes for COM2.

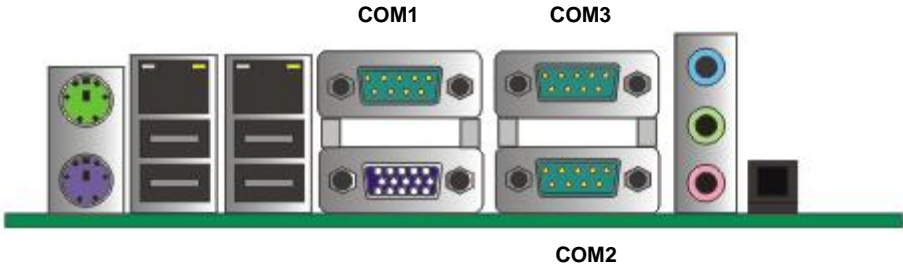

Connector: **COM2**

Type: 9-pin D-sub male connector on bracket for COM2

Pin	Description	Pin	Description
1	DCD/422TX-/485-	2	RXD/422TX+/485+
3	TXD/422RX+	4	DTR/422RX-
5	GND	6	DSR
7	RTS	8	CTS
9	RI	10	N/C

Setting RS-232 & RS-422 & RS-485 for COM2

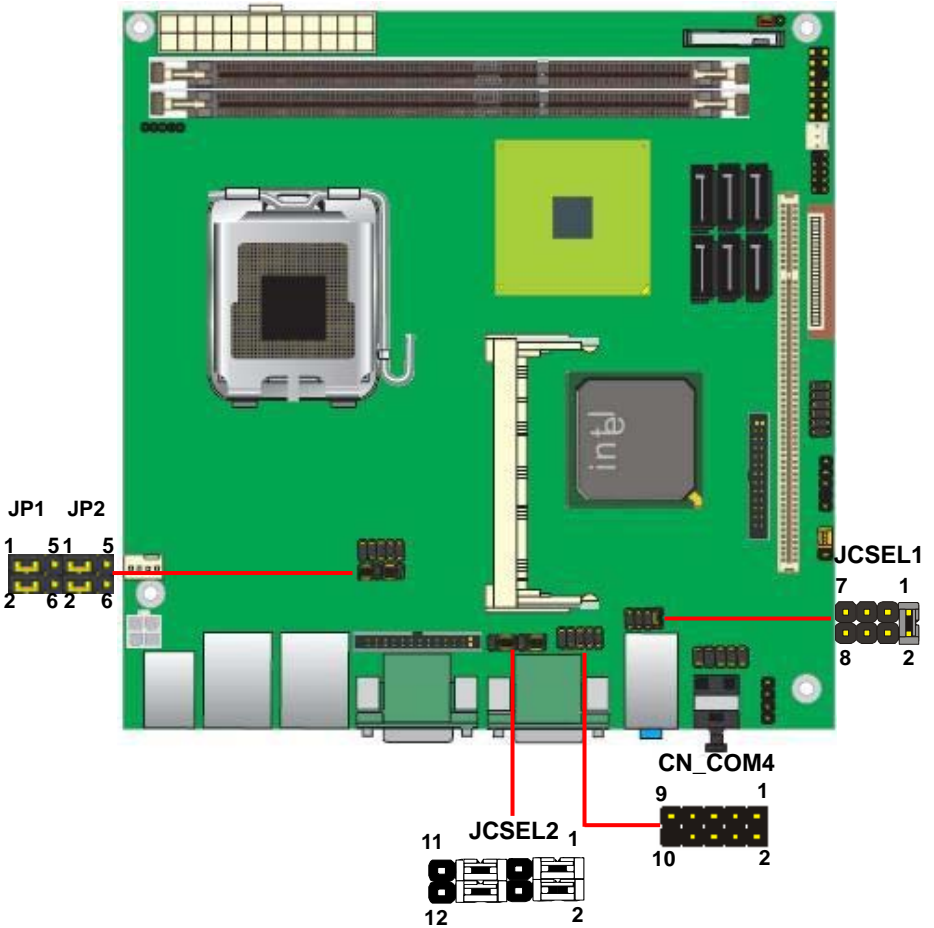

Function	JCSEL1	JCSEL2
SIR		
RS-485		
RS-422		
RS-232		

Default setting:

JCSEL1: (1-2) JCSEL2: (1-3, 2-4, 7-9, 8-10)

Jumper: **JP1/JP2 (COM1/2)**

Type: onboard 6-pin header

Power Mode	JP1/JP2
Pin 1 with 5V Power	1-3,4-6
Pin 9 with 12V Power	2-4,3-5
<b>Default setting: 3-5, 4-6</b>	



## 2.15 <Switch and Indicator>

The **JFRNT** provides front control panel of the board, such as power button, reset and beeper, etc. Please check well before you connecting the cables on the chassis.

Connector: **JFRNT**

Type: onboard 14-pin (2 x 7) 2.54-pitch header

Function	Signal	PIN		Signal	Function
IDE LED	HDLED+	1	2	PWDLED+	Power LED
	HDLED-	3	4	N/C	
Reset	Reset+	5	6	PWDLED-	Speaker
	Reset-	7	8	SPKIN+	
N/C		9	10	N/C	
Power Button	PWRBT+	11	12	N/C	
	PWRBT-	13	14	SPKIN-	

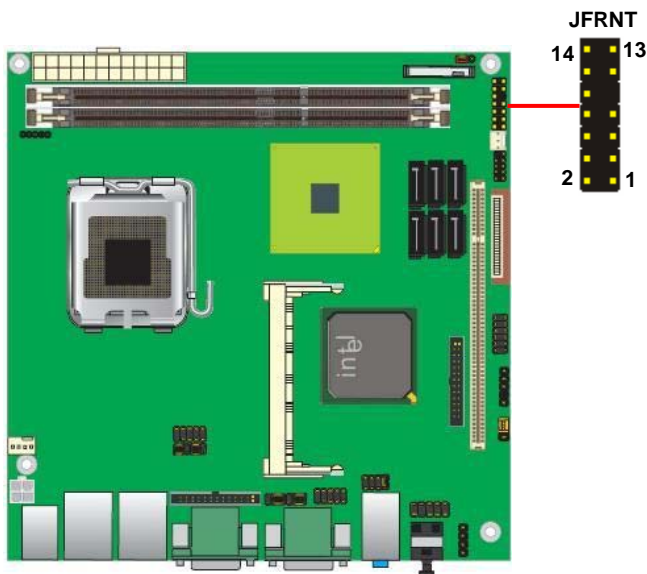

**(This Page is Left for Blank)**

## Chapter 3 <System Configuration>

### 3.1 <SATA configuration>

SATA Mode:

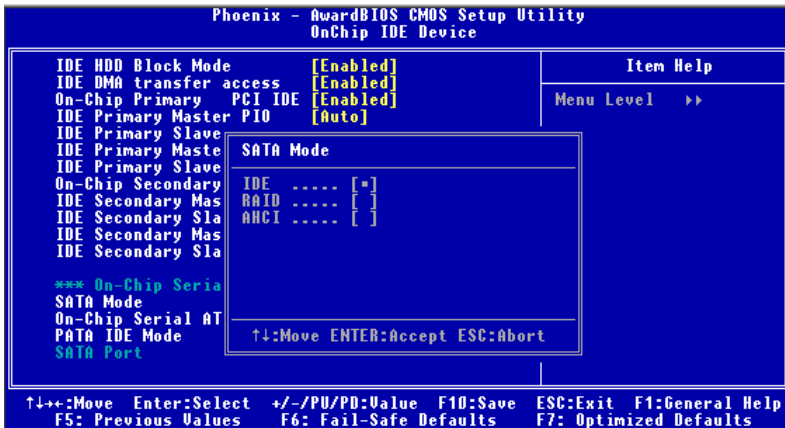

This option can let you select whether the Serial ATA hard drives would work under normal IDE mode or RAID mode. The RAID mode need more than one HDD is applied.

## 3.2 <SATA RAID Configuration>

The board integrates Intel® ICH10DO with RAID function for Serial ATA II drives, and supports the configurations below:

**RAID 0 (Striping):** Two hard drives operating as one drive for optimized data R/W performance. It needs two unused drives to build this operation.

**RAID 1 (Mirroring):** Copies the data from first drive to second drive for data security, and if one drive fails, the system would access the applications to the workable drive. It needs two unused drives or one used and one unused drive to build this operation. The second drive must be the same or larger size than first one.

### **RAID 5 (striping with parity)**

A RAID 5 array contains three or more hard drives where the data is divided into manageable blocks called strips. Parity is a mathematical method for recreating data that was lost from a single drive, which increases fault-tolerance. The data and parity are striped across all the hard drives in the array. The parity is striped in a rotating sequence to reduce bottlenecks associated with the parity calculations.

### **RAID 10 (RAID 0+1)**

A RAID 10 array uses four hard drives to create a combination of RAID levels 0 and 1. The data is striped across a two-drive array forming the RAID 0 component. Each of the drives in the RAID 0 array is then mirrored by a RAID 1 component.

**Intel Matrix Storage Technology:** This technology would allow you to use **RAID 0+1** mode on only two drives (4 drives needed on traditional RAID 0+1). It will create two partitions on each hard drive to simulate **RAID 0** and **RAID 1**. It also can let you modify the partition size without re-formatted.

*For more information of Intel Matrix Storage Technology, please visit Intel's website.*

If you need to install an operation system on the RAID set, please use the driver disk attached in the package when it informs you to obtain the RAID drivers.



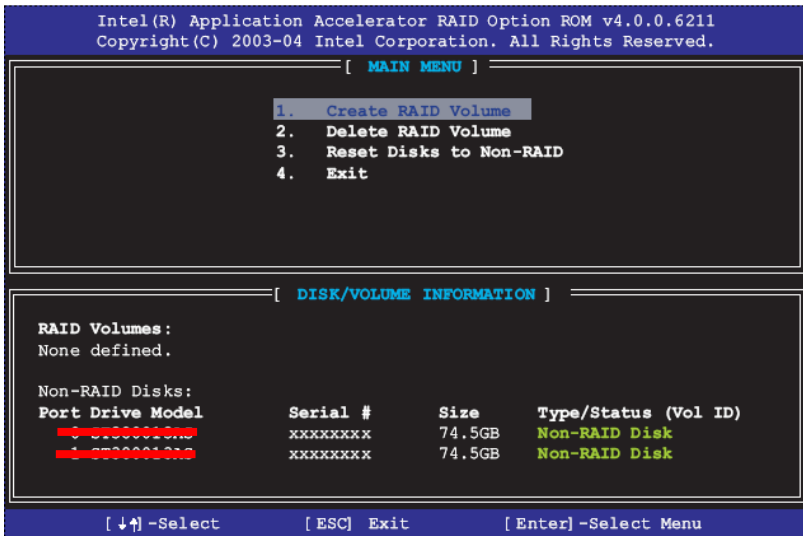

Please press <CTRL+I> to enter the RAID configuration menu.

You can setup the RAID under operation system for Microsoft® Windows XP SP1 or Windows 2000 SP4 version, please install the Intel® Application Accelerator Ver.4.5 later to support RAID configuration with Intel® Matrix Storage Technology.

1. After installing Intel Application Accelerator, please execute Intel® Storage Utility.

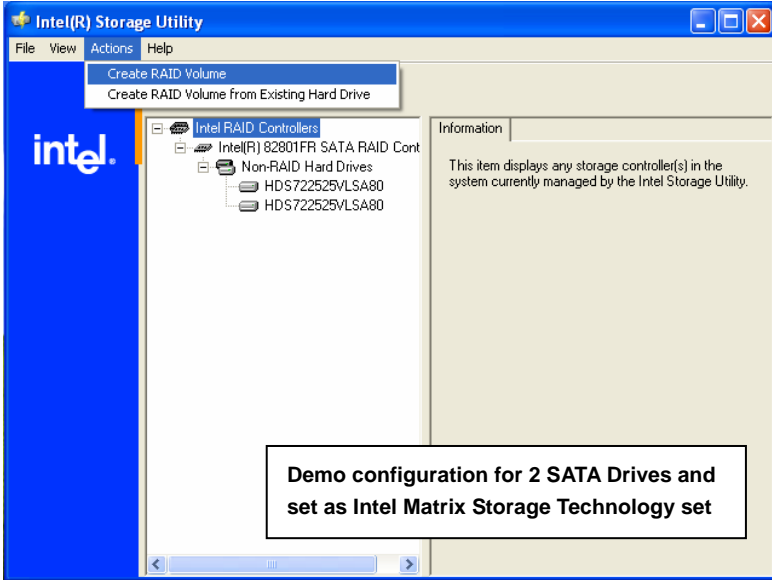

2. Select Actions to Create RAID Volume

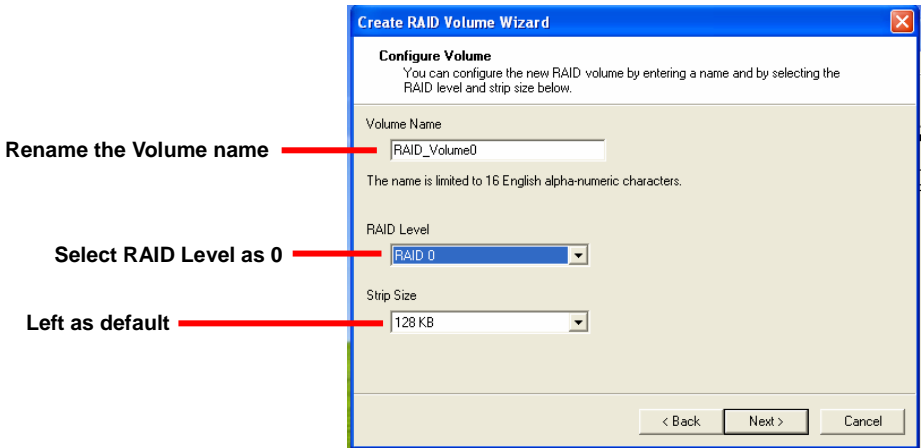

3. Please select two hard drives to prepare to set the RAID volume

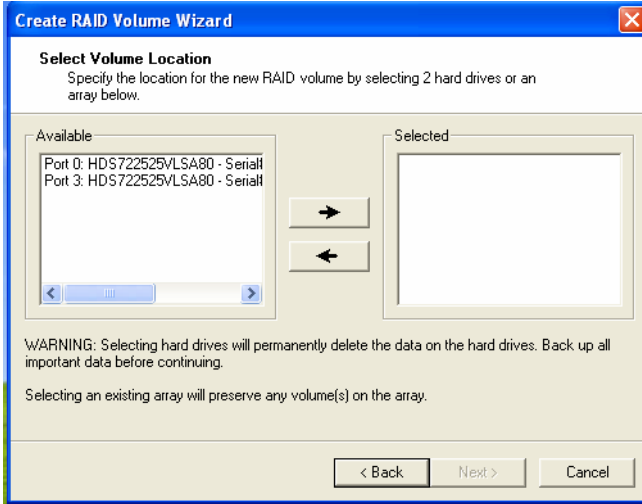

4. Specify the Volume size

**Tune this bar to specify the volume size, if you specify the volume size lower than maximum, you can create a second volume for another RAID set. (Make RAID 0+1 on only two hard drives)**

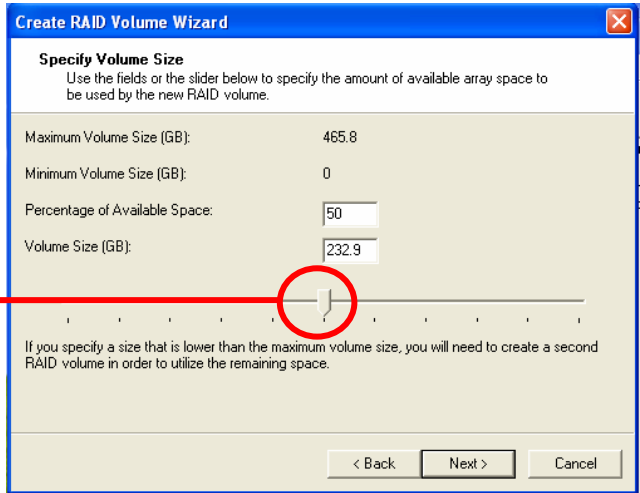

5. Repeat the step 1 to create second volume as RAID Level 1.

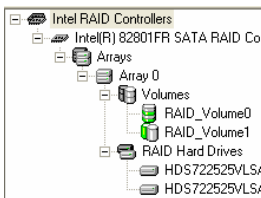

**For other configuration set please click Help on tool bar.**

### 3.3 <Audio Configuration>

The board integrates Intel® ICH10DO with REALTEK® ALC888 codec. It can support 2-channel sound under system configuration. Please follow the steps below to setup your sound system.

1. Install REALTEK HD Audio driver.

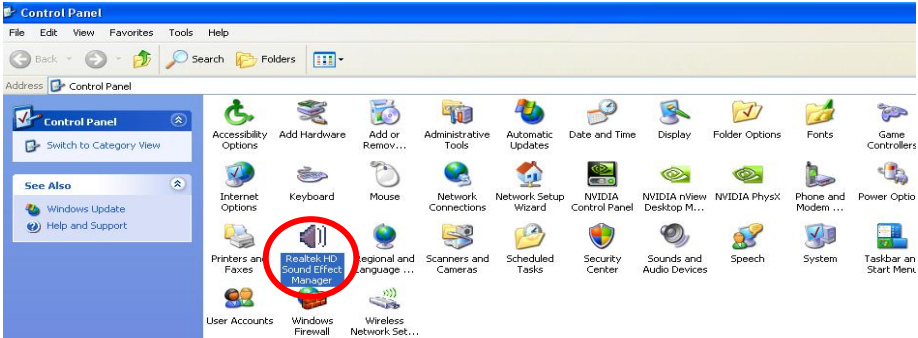

2. Launch the control panel and Sound Effect Manager.
3. Select Speaker Configuration



4. Select the sound mode to meet your speaker system.

### 3.4 <Video Memory Setup>

Based on Intel® Q45 chipset with GMA (Graphic Media Accelerator) 4500, the board supports Intel® DVMT (Dynamic Video Memory Technology) 3.0, which would allow the video memory be triggered up to 384MB.

To support DVMT, you need to install the Intel GMA4500 Driver with supported OS.

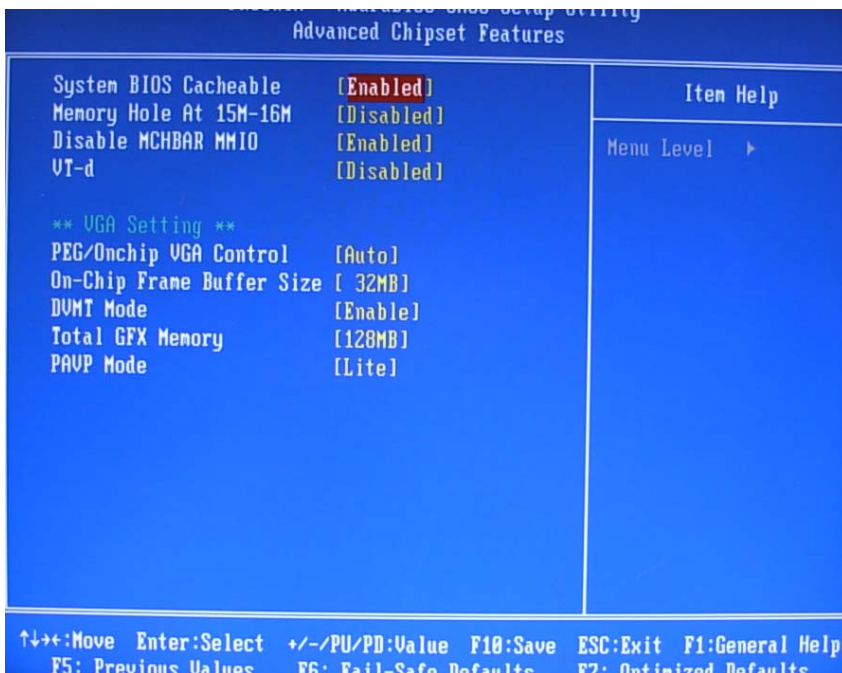

#### BIOS Setup:

##### On-Chip Frame Buffer Size:

This item can let you select video memory which been allocated for legacy VGA and SVGA graphics support and compatibility. The available option is **32MB** and **128MB**.

**Total GFX Memory Size:**

This item can let you select a static amount of page-locked graphics memory; which will be allocated during driver initialization. Once you select the memory amount, it will be no longer available for system memory.

**DVMT Memory Size:**

This item can let you select a maximum size of dynamic amount usage of video memory, the system would configure the video memory depends on your application, this item is strongly recommend to be selected as **MAX DVMT**.

**Fixed + DVMT Memory Size:**

You can select the fixed amount and the DVMT amount at the same time for a guaranteed video memory and additional dynamic video memory

Notice:

1. The On-Chip Frame Buffer Size would be included in the Total GFX Memory Size.

## 3.5 <Display Properties Setting>

Based on Intel Q45 GMCH with GMA3000 (Graphic Media Accelerator), the board supports two DACs for display device as different resolution and color bit.

Please install the Intel Graphic Driver before you starting setup display devices.

1. Click right button on the desktop to lunch **display properties**

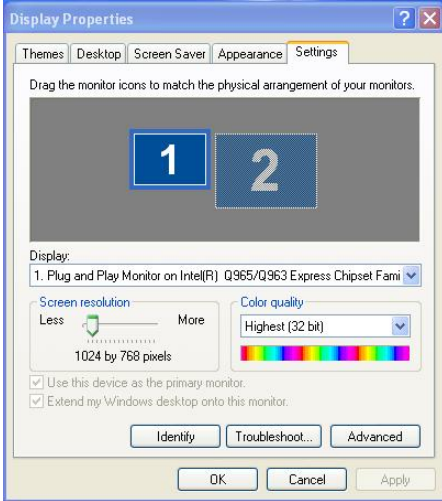

2. Click **Advanced** button for more specificity setup.

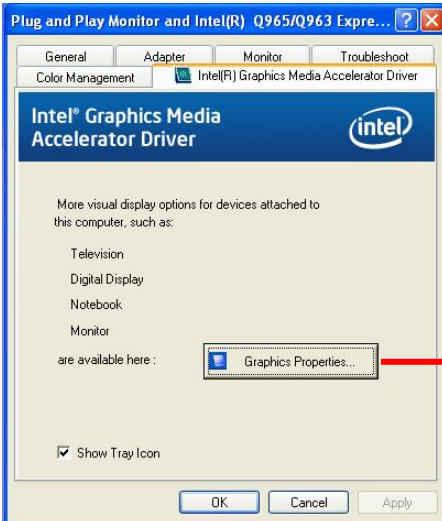

Click Graphics Properties... for advanced setup

3. This setup options can let you define each device settings.

Click **Monitor** to setup the CRT monitor for Colors, Resolution and Refresh Rate

Click **Intel® Dual Display Clone** to setup the dual display mode as same screen

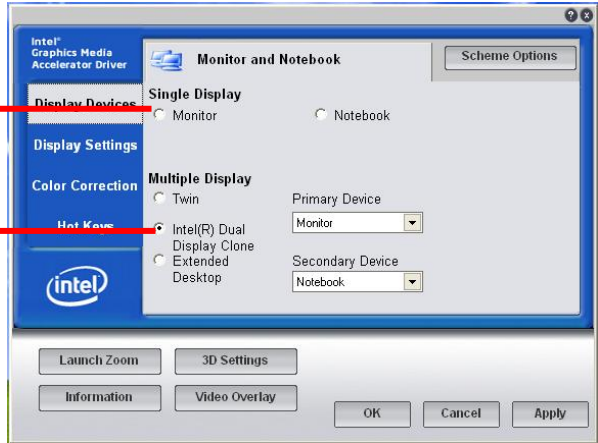

Set the main display device here

Click **Extended Desktop** to setup the dual display mode as different screen display

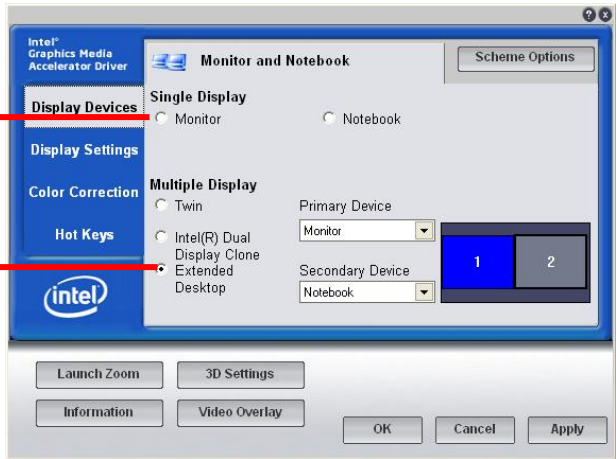



## Chapter 4 <BIOS Setup>

The motherboard uses the Award BIOS for the system configuration. The Award BIOS in the single board computer is a customized version of the industrial standard BIOS for IBM PC AT-compatible computers. It supports Intel x86 and compatible CPU architecture based processors and computers. The BIOS provides critical low-level support for the system central processing, memory and I/O sub-systems.

The BIOS setup program of the single board computer let the customers modify the basic configuration setting. The settings are stored in a dedicated battery-backed memory, NVRAM, retains the information when the power is turned off. If the battery runs out of the power, then the settings of BIOS will come back to the default setting.

The BIOS section of the manual is subject to change without notice and is provided here for reference purpose only. The settings and configurations of the BIOS are current at the time of print, and therefore they may not be exactly the same as that displayed on your screen.

To activate CMOS Setup program, press <DEL> key immediately after you turn on the system. The following message "Press DEL to enter SETUP" should appear in the lower left hand corner of your screen. When you enter the CMOS Setup Utility, the Main Menu will be displayed as **Figure 4-1**. You can use arrow keys to select your function, press <Enter> key to accept the selection and enter the sub-menu.

**Figure 4-1** CMOS Setup Utility Main Screen



**(This Page is Left for Blank)**

## Appendix A <I/O Port Pin Assignment>

### A.1 <Serial ATA Port>

Connector: **S\_ATA1/2/3/4/5/6**

Type: 7-pin wafer connector

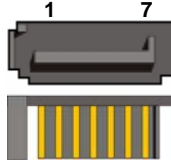

1	2	3	4	5	6	7
GND	RSATA_TXP1	RSATA_TXN1	GND	RSATA_RXN1	RSATA_RXP1	GND

### A.2 <Floppy Port>

Connector: **FDD**

Type: 26-pin connector



Pin	Description	Pin	Description
1	VCC	2	INDEX
3	VCC	4	DRV0
5	VCC	6	DSKCHG
7	DRV1	8	N/C
9	MTR1	10	MTR0
11	RPM	12	DIR
13	N/C	14	STEP
15	Ground	16	WRITE DATA
17	Ground	18	WRITE GATE
19	N/C	20	TRACK 0
21	N/C	22	WRPTR
23	Ground	24	RDATA-
25	Ground	26	SEL

### A.3 <IrDA Port>

Connector: **CN\_IR**

Type: 5-pin header for SIR Ports



Pin	Description
1	VCC
2	N/C
3	IRRX
4	Ground
5	IRTX

### A.4 <Serial Port>

Connector: **COM1/2/3**

Type: 9-pin D-sub male connector on bracket

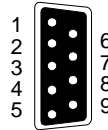

Pin	Description	Pin	Description
1	DCD	6	DSR
2	SIN	7	RTS
3	SO	8	CTS
4	DTR	9	RI
5	Ground		

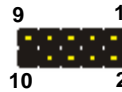

Connector: **COM4**

Type: 9-pin header connector for COM4

Pin	Description	Pin	Description
1	DCD	6	DSR
2	SIN	7	RTS
3	SO	8	CTS
4	DTR	9	RI
5	Ground		

## A.5 <VGA Port>

Connector: **CRT1**

Type: 15-pin D-sub female connector on bracket

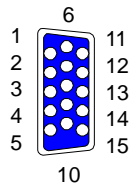

Pin	Description	Pin	Description	Pin	Description
1	RED	6	Ground	11	N/C
2	GREEN	7	Ground	12	DDC_DA
3	BLUE	8	Ground	13	HSYNC
4	N/C	9	+5V	14	VSYNC
5	Ground	10	Ground	15	DDC_CLK

## A.6 <LAN Port>

Connector: **RJ45/2**

Type: RJ45 connector with LED on bracket



Pin	1	2	3	4	5
Description	TRD0+	TRD0-	TRD1+	TRD2+	TRD2-

Pin	6	7	8	9	10
Description	TRD1-	TRD3+	TRD3-	NC	NC

## Appendix B <System Resources>

### B.1 <I/O Port Address Map>

[00000000 - 0000000F]	Direct memory access controller
[00000000 - 00000CF7]	PCI bus
[00000010 - 0000001F]	Motherboard resources
[00000020 - 00000021]	Programmable interrupt controller
[00000022 - 0000003F]	Motherboard resources
[00000040 - 00000043]	System timer
[00000044 - 0000005F]	Motherboard resources
[00000060 - 00000060]	Standard 101/102-Key or Microsoft Natural PS/2 Keyboard
[00000061 - 00000061]	System speaker
[00000062 - 00000063]	Motherboard resources
[00000064 - 00000064]	Standard 101/102-Key or Microsoft Natural PS/2 Keyboard
[00000065 - 0000006F]	Motherboard resources
[00000070 - 00000073]	System CMOS/real time clock
[00000074 - 0000007F]	Motherboard resources
[00000080 - 00000090]	Direct memory access controller
[00000091 - 00000093]	Motherboard resources
[00000094 - 0000009F]	Direct memory access controller
[000000A0 - 000000A1]	Programmable interrupt controller
[000000A2 - 000000BF]	Motherboard resources
[000000C0 - 000000DF]	Direct memory access controller
[000000E0 - 000000EF]	Motherboard resources
[000000F0 - 000000FF]	Numeric data processor
[00000274 - 00000277]	ISAPNP Read Data Port
[00000279 - 00000279]	ISAPNP Read Data Port
[00000280 - 00000287]	Communications Port (COM3)
[00000288 - 0000028F]	Communications Port (COM4)
[000002F8 - 000002FF]	Communications Port (COM2)
[000003B0 - 000003BB]	Intel(R) Q45/Q43 Express Chipset
[000003C0 - 000003DF]	Intel(R) Q45/Q43 Express Chipset
[000003F0 - 000003F5]	Standard floppy disk controller
[000003F7 - 000003F7]	Standard floppy disk controller
[000003F8 - 000003FF]	Communications Port (COM1)
[00000400 - 000004BF]	Motherboard resources
[000004D0 - 000004D1]	Motherboard resources
[00000500 - 0000051F]	Intel(R) ICH10 Family SMBus Controller - 3A60
[00000880 - 0000088F]	Motherboard resources
[00000A79 - 00000A79]	ISAPNP Read Data Port

[00000D00 - 0000FFFF] PCI bus  
[00008000 - 00008FFF] Intel(R) ICH10 Family PCI Express Root Port 2 - 3A72  
[00008C00 - 00008C1F] Intel(R) 82574L Gigabit Network Connection #2  
[0000A000 - 0000AFFF] Intel(R) ICH10 Family PCI Express Root Port 1 - 3A70  
[0000AC00 - 0000AC1F] Intel(R) 82574L Gigabit Network Connection  
[0000B000 - 0000B00F] Intel(R) ICH10 Family 2 port Serial ATA Storage Controller 2 - 3A06  
[0000B400 - 0000B40F] Intel(R) ICH10 Family 2 port Serial ATA Storage Controller 2 - 3A06  
[0000B800 - 0000B803] Intel(R) ICH10 Family 2 port Serial ATA Storage Controller 2 - 3A06  
[0000BC00 - 0000BC07] Intel(R) ICH10 Family 2 port Serial ATA Storage Controller 2 - 3A06  
[0000C000 - 0000C003] Intel(R) ICH10 Family 2 port Serial ATA Storage Controller 2 - 3A06  
[0000C400 - 0000C407] Intel(R) ICH10 Family 2 port Serial ATA Storage Controller 2 - 3A06  
[0000CC00 - 0000CC0F] Intel(R) ICH10 Family 4 port Serial ATA Storage Controller 1 - 3A00  
[0000D000 - 0000D00F] Intel(R) ICH10 Family 4 port Serial ATA Storage Controller 1 - 3A00  
[0000D400 - 0000D403] Intel(R) ICH10 Family 4 port Serial ATA Storage Controller 1 - 3A00  
[0000D800 - 0000D807] Intel(R) ICH10 Family 4 port Serial ATA Storage Controller 1 - 3A00  
[0000DC00 - 0000DC03] Intel(R) ICH10 Family 4 port Serial ATA Storage Controller 1 - 3A00  
[0000E000 - 0000E007] Intel(R) ICH10 Family 4 port Serial ATA Storage Controller 1 - 3A00  
[0000E400 - 0000E41F] Intel(R) ICH10 Family USB Universal Host Controller - 3A66  
[0000E800 - 0000E81F] Intel(R) ICH10 Family USB Universal Host Controller - 3A65  
[0000EC00 - 0000EC1F] Intel(R) ICH10 Family USB Universal Host Controller - 3A64  
[0000F000 - 0000F01F] Intel(R) ICH10 Family USB Universal Host Controller - 3A69  
[0000F400 - 0000F41F] Intel(R) ICH10 Family USB Universal Host Controller - 3A68  
[0000F800 - 0000F81F] Intel(R) ICH10 Family USB Universal Host Controller - 3A67  
[0000FC00 - 0000FC07] Intel(R) Q45/Q43 Express Chipset

**B.2 <Memory Address Map>**

[00000000 - 0009FFFF]	System board
[000A0000 - 000BFFFF]	Intel(R) Q45/Q43 Express Chipset
[000A0000 - 000BFFFF]	PCI bus
[000C0000 - 000DFFFF]	PCI bus
[000E0000 - 000EFFFF]	System board
[000F0000 - 000FFFFF]	System board
[00100000 - 7DC8FFFF]	System board
[7DC90000 - 7DCFFFFF]	System board
[7DD00000 - 7DDFFFFF]	System board
[7DD00000 - FEBFFFFF]	PCI bus
[D0000000 - DFFFFFFF]	Intel(R) Q45/Q43 Express Chipset
[E0000000 - EFFFFFFF]	Motherboard resources
[FD400000 - FD7FFFFF]	Intel(R) Q45/Q43 Express Chipset
[FD800000 - FD8FFFFF]	Intel(R) ICH10 Family PCI Express Root Port 1 - 3A70
[FD900000 - FD9FFFFF]	Intel(R) ICH10 Family PCI Express Root Port 1 - 3A70
[FD9C0000 - FD9DFFFF]	Intel(R) 82574L Gigabit Network Connection
[FD9FC000 - FD9FFFFF]	Intel(R) 82574L Gigabit Network Connection
[FDD00000 - FDDFFFFF]	Intel(R) ICH10 Family PCI Express Root Port 2 - 3A72
[FDE00000 - FDEFFFFF]	Intel(R) ICH10 Family PCI Express Root Port 2 - 3A72
[FDEC0000 - FDEDFFFF]	Intel(R) 82574L Gigabit Network Connection #2
[FDEFC000 - FDEFFFFF]	Intel(R) 82574L Gigabit Network Connection #2
[FDFF8000 - FDFFBFFF]	Microsoft UAA Bus Driver for High Definition Audio
[FDFFD000 - FDFFD0FF]	Intel(R) ICH10 Family SMBus Controller - 3A60
[FDFFE000 - FDFFE3FF]	Intel(R) ICH10 Family USB Enhanced Host Controller - 3A6A
[FDFFF000 - FDFFF3FF]	Intel(R) ICH10 Family USB Enhanced Host Controller - 3A6C
[FEB00000 - FEBFFFFF]	Intel(R) Q45/Q43 Express Chipset
[FEC00000 - FEC00FFF]	System board
[FED00000 - FED000FF]	System board
[FED00000 - FED003FF]	High precision event timer
[FED13000 - FED1FFFF]	System board
[FED20000 - FED9FFFF]	System board
[FEE00000 - FEE00FFF]	System board
[FFB00000 - FFB7FFFF]	System board
[FFB80000 - FFBFFFFF]	Intel(R) 82802 Firmware Hub Device
[FFF00000 - FFFFFFFF]	System board



**B.3 <System IRQ Resources>**

- (ISA) 0 High precision event timer
- (ISA) 1 Standard 101/102-Key or Microsoft Natural PS/2 Keyboard
- (ISA) 3 Communications Port (COM2)
- (ISA) 3 Communications Port (COM3)
- (ISA) 4 Communications Port (COM1)
- (ISA) 4 Communications Port (COM4)
- (ISA) 6 Standard floppy disk controller
- (ISA) 8 High precision event timer
- (ISA) 9 Microsoft ACPI-Compliant System
- (ISA) 12 PS/2 Compatible Mouse
- (ISA) 13 Numeric data processor
- (PCI) 11 Intel(R) ICH10 Family SMBus Controller - 3A60
- (PCI) 16 Intel(R) 82574L Gigabit Network Connection
- (PCI) 16 Intel(R) ICH10 Family PCI Express Root Port 1 - 3A70
- (PCI) 16 Intel(R) ICH10 Family USB Universal Host Controller - 3A67
- (PCI) 16 Intel(R) Q45/Q43 Express Chipset
- (PCI) 17 Intel(R) 82574L Gigabit Network Connection #2
- (PCI) 17 Intel(R) ICH10 Family PCI Express Root Port 2 - 3A72
- (PCI) 18 Intel(R) ICH10 Family USB Enhanced Host Controller - 3A6C
- (PCI) 18 Intel(R) ICH10 Family USB Universal Host Controller - 3A66
- (PCI) 19 Intel(R) ICH10 Family 2 port Serial ATA Storage Controller 2 - 3A06
- (PCI) 19 Intel(R) ICH10 Family 4 port Serial ATA Storage Controller 1 - 3A00
- (PCI) 19 Intel(R) ICH10 Family USB Universal Host Controller - 3A69
- (PCI) 19 Intel(R) ICH10 Family USB Universal Host Controller - 3A65
- (PCI) 21 Intel(R) ICH10 Family USB Universal Host Controller - 3A68
- (PCI) 22 Microsoft UAA Bus Driver for High Definition Audio
- (PCI) 23 Intel(R) ICH10 Family USB Enhanced Host Controller - 3A6A
- (PCI) 23 Intel(R) ICH10 Family USB Universal Host Controller - 3A64

## Appendix C <Flash BIOS>

### C.1 <BIOS Auto Flash Tool>

The board is based on Award BIOS and can be updated easily by the BIOS auto flash tool. You can download the tool online at the address below:

<http://www.award.com>

<http://www.commell.com.tw/support/support.htm>

File name of the tool is "awdfash.exe", it's the utility that can write the data into the BIOS flash ship and update the BIOS.

### C.2 <Flash Method>

1. Please make a bootable floppy disk.
2. Get the last .bin files you want to update and copy it into the disk.
3. Copy awardflash.exe to the disk.
4. Power on the system and flash the BIOS. (Example: C:/ awardflash XXX.bin)
5. Re-star the system.

Any question about the BIOS re-flash please contact your distributors or visit the web-site at below:

<http://www.commell.com.tw/support/support.htm>

## Appendix D <Programming GPIO's>

The GPIO can be programmed with the MSDOS debug program using simple IN/OUT commands. The following lines show an example how to do this.

GPIO0.....GPIO7 bit0.....bit7

```
-o 2E 87           ;enter configuration
-o 2E 87
-o 2E 07
-o 2F 09           ;enable GPIO function
-o 2E 30
-o 2F 02           ;enable GPIO configuration
-o 2E F0
-o 2F xx           ;set GPIO as input/output; set '1' for input,'0'for output
-o 2E F1
-o 2F xx           ;if set GPIO's as output,in this register its value can be set
```

Optional :

```
-o 2E F2
-o 2F xx           ; Data inversion register ; '1' inverts the current value of the bits , '0'
                   leaves them as they are
-o 2E 30
-o 2F 01           ; active GPIO's
```

For further information ,please refer to Winbond W83627DHG datasheet.

## Appendix E <Watch Dog timer Setting >

The watchdog timer makes the system auto-reset while it stops to work for a period. The integrated watchdog timer can be setup as system reset mode by program.

### Timeout Value Range

- 1 to 255
- Second or Minute

### Program Sample

Watchdog timer setup as system reset with 5 second of timeout

```

2E, 87
2E, 87
2E, 07
2F, 08      Logical Device 8
2E, 30      Activate
2F, 01
2E, F5      Set as Second*
2F, 00
2E, F6      Set as 5
2F, 05
    
```

\* Minute: bit 3 = 0; Second: bit 3 = 1

You can select Timer setting in the BIOS, after setting the time options, the system will reset according to the period of your selection.



## Contact Information

Any advice or comment about our products and service, or anything we can help you please don't hesitate to contact with us. We will do our best to support you for your products, projects and business.

### Taiwan Commate Computer Inc.

---

Address	19F, No. 94, Sec. 1, Xintai 5th Rd., Xizhi Dist., New Taipei City 22102, Taiwan
TEL	+886-2-26963909
FAX	+886-2-26963911
Website	<a href="http://www.commell.com.tw">http://www.commell.com.tw</a>
E-Mail	<a href="mailto:info@commell.com.tw">info@commell.com.tw</a> (General Information) <a href="mailto:tech@commell.com.tw">tech@commell.com.tw</a> (Technical Support)
Facebook	<a href="https://www.facebook.com/pages/Taiwan-Commate-Computer-Inc/547993955271899">https://www.facebook.com/pages/Taiwan-Commate-Computer-Inc/547993955271899</a>
Twitter	<a href="https://twitter.com/Taiwan_Commate">https://twitter.com/Taiwan_Commate</a>

---

**Commell is a brand name of Taiwan commate computer Inc.**