

LS-378

3.5 inch Motherboard

User's Manual

Edition 1.5

2016/08/16

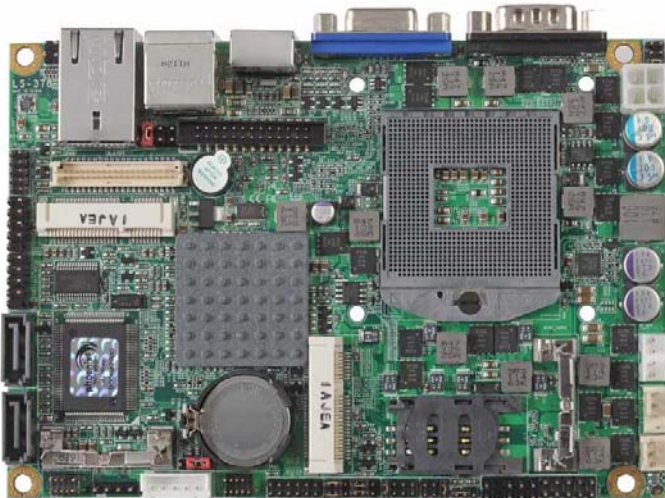

Copyright

Copyright 2012, all rights reserved. This document is copyrighted and all rights are reserved. The information in this document is subject to change without prior notice to make improvements to the products.

This document contains proprietary information and protected by copyright. No part of this document may be reproduced, copied, or translated in any form or any means without prior written permission of the manufacturer.

All trademarks and/or registered trademarks contains in this document are property of their respective owners.

Disclaimer

The company shall not be liable for any incidental or consequential damages resulting from the performance or use of this product.

The company does not issue a warranty of any kind, express or implied, including without limitation implied warranties of merchantability or fitness for a particular purpose.

The company has the right to revise the manual or include changes in the specifications of the product described within it at any time without notice and without obligation to notify any person of such revision or changes.

Trademark

All trademarks are the property of their respective holders.

Any questions please visit our website at <http://www.commell.com.tw>

Packing List:

Please check the package content before you starting using the board.

Hardware:

LS-378 3.5" Miniboard x 1

Cable Kit:



SATA Cable x 2
(OALSATA3-L)/ (1045029)

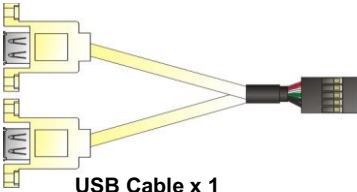

USB Cable x 1
(OALUSBA-3)/ (1040173)



PS/2 Keyboard & Mouse Cable x 1
(OALPS2/MKN)/ (1040134)



COM Port Cable x 1
(OALES-BKU1NB)/ (1040086)



CPU Cooler x 1
(OHS-P-M-H)/ (1190058)



DC Power Cable x 1
(OALDC-A)/ (1040433)



DVI module with bracket x 1
(BADPDVI_A&OALDVI-P)
(4120008011 & 1040075)

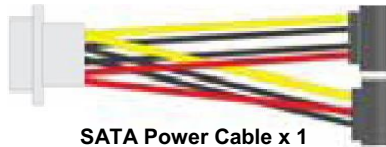

SATA Power Cable x 1
(OAL4P-S2)/ (1040054)



1 to 3 power output cable x 1
(OAL4P-2)/ (1040051)



Audio Cable x 1
(OALPJ-HDUNB)/ (1040123)

Printed Matters:

Driver CD (Including User's Manual) x 1

Index

Chapter 1 <Introduction>	6
1.1 <Product Overview>	6
1.2 <Product Specification>	7
1.3 <Mechanical Drawing>	8
1.4 <Block Diagram>	9
Chapter 2 <Hardware Setup>	10
2.1 <Connector Location>	10
2.2 <Jumper Location & Reference>	12
2.3 <Connector Reference>	13
2.3.1 <Internal Connectors>	13
2.3.2 <External Connectors>	13
2.4 <CPU and Memory Setup>	14
2.4.1 <CPU Setup>	14
2.4.2 <Memory Setup>	15
2.5 <CMOS & ATX Setup>	16
2.6 <Serial ATA Interface>	17
2.7 <Ethernet Interface>	18
2.8 <Onboard Display Interface>	19
2.8.1 <Analog Display>	19
2.8.2 <Digital Display>	20
2.8.3 <DVI Interface>	25
2.9 <Integrated Audio Interface>	26
2.10 <USB Interface>	28
2.11 <Serial Port>	29
2.12 <PCIE Mini Card and SIM Interface>	31
2.12.1 <SIM Setup>	33
2.13 <GPIO and SMBUS Interface>	35
2.14 <Power Supply and Fan Interface >	35
2.14 <Power Supply and Fan Interface >	36

2.14.1 <Power Input>	36
2.14.2 <Power Output>	36
2.14.3 <Fan connector>	37
2.15 <Switch and Indicator>	38
Chapter 3 <System Setup>	39
3.1 <Audio Configuration>	39
3.2 <Display Properties Setting>	40
3.3 <SATA configuration>	42
3.4 <SATA RAID Configuration>	43
Chapter 4 <BIOS Setup>	44
Appendix A <I/O Port Pin Assignment>	46
A.1 <Serial ATA Port>	46
A.2 <IrDA Port>	46
A.3 <VGA Port>	46
A.4 <LAN Port>	46
A.5 <LAN LED Port>	47
A.6 <LPC Port>	47
Appendix B <Flash BIOS>	48
B.1 <Flash Tool>	48
B.2 <Flash BIOS Procedure>	48
Appendix C <System Resources>	49
C.1 <I/O Port Address Map>	49
C.2 <Memory Address Map>	51
C.3 <System DMA & IRQ Resources>	52
Appendix D <Programming GPIO's>	53
Appendix E <Programming Watchdog Timer >	54
Contact Information	55

(This page is left for blank)

Chapter 1 <Introduction>

1.1 <Product Overview>

LS-378 the 2nd Generation Intel of the 3.5 inch miniboard, supports 2nd Generation Intel® Core™ i7, Core™ i5, Core™ i3 and Celeron® Mobile Processor and features Intel QM67 chipset, integrated HD Graphics, DDR3 memory, REALTEK High Definition Audio, Serial ATA with RAID function for a system and Intel Gigabit LAN.

Intel Sandy Bridge Processor

The 2nd Generation Intel® Core™ processor family mobile is the next generation of 64-bit, multi-core mobile processor built on 32- nanometer process technology. Based on a new micro-architecture.

New features for Intel QM67 chipset

The board integrates Intel QM67 chipset, supports integrated HD Graphics, built-in high speed mass storage interface of Serial ATA interface with RAID function, High Definition Audio with 2 channels surrounding sound.

All in One multimedia solution

Based on Intel QM67 chipset, the board provides high performance onboard graphics, 24-bit dual channel LVDS interface, DVI and 2 channels High Definition Audio, to meet the very requirement of the multimedia application.

Flexible Extension Interface

The board provides two PCIE mini card socket.

1.2 <Product Specification>

General Specification

Form Factor	3.5 inch motherboard
CPU	2 nd Generation Intel® Core™ i7, Core™ i5, Core™ i3 and Celeron® Mobile Processor Package type: rPGA988B
Memory	1 x DDRIII SO-DIMM 1066/1333/1600 MHz up to 8GB Non-ECC, unbuffered memory supported only
Chipset	Intel QM67
Real Time Clock	Chipset integrated RTC with onboard lithium battery
Watchdog Timer	Generates a system reset with internal timer for 1min/s ~255min/s
Power Management	Supports ACPI 2.0 compliant,
Serial ATA Interface	2 x serial ATAIII interface with 600MB/s transfer rate Support RAID 0, 1and Intel Rapid Storage Technology
VGA Interface	Onboard DSUB15 connector for VGA interface
LVDS Interface	Onboard 24-bit dual channel LVDS connector with +3.3V/+5V/+12V supply
DVI Interface	Chrontel CH7318 Transmitter with 26-pin DVI connector
Audio Interface	Realtek ALC888 HD Audio
LAN Interface	Intel 82579LM Gigabit LAN
GPIO interface	Onboard programmable 8-bit Digital I/O interface
Extended Interface	2 x PCIE mini card socket, 1 x SIM socket
Internal I/O Port	1 x RS232/422/485, 1 x SMBUS, 1 x GPIO, 4 x USB2.0 ports, 1 x IrDA, 1 x DVI ,1 x LVDS, 2 x Serial ATAIII, 1 x Front panel Audio and 1 x CDIN
External I/O Port	1 x PS/2, 1 x LAN port, 1 x VGA port, 2 x USB2.0 ports and 1 x RS232
Power Requirement	9~24V full range DC Input
Dimension	146mm x 101mm
Temperature	Operating within 0~60 centigrade Storage within -20~85 centigrade

Ordering Code

LS-378DXT	Intel PGA988B+ QM67 Onboard VGA, LVDS, DVI, LAN, USB2.0, HD Audio, SATAIII, SMBUS, LPC, SIM, GPIO, PCI Express mini card.
------------------	---

The specifications may be different as the actual production.

For further product information please visit the website at <http://www.commel.com.tw>

1.3 <Mechanical Drawing>

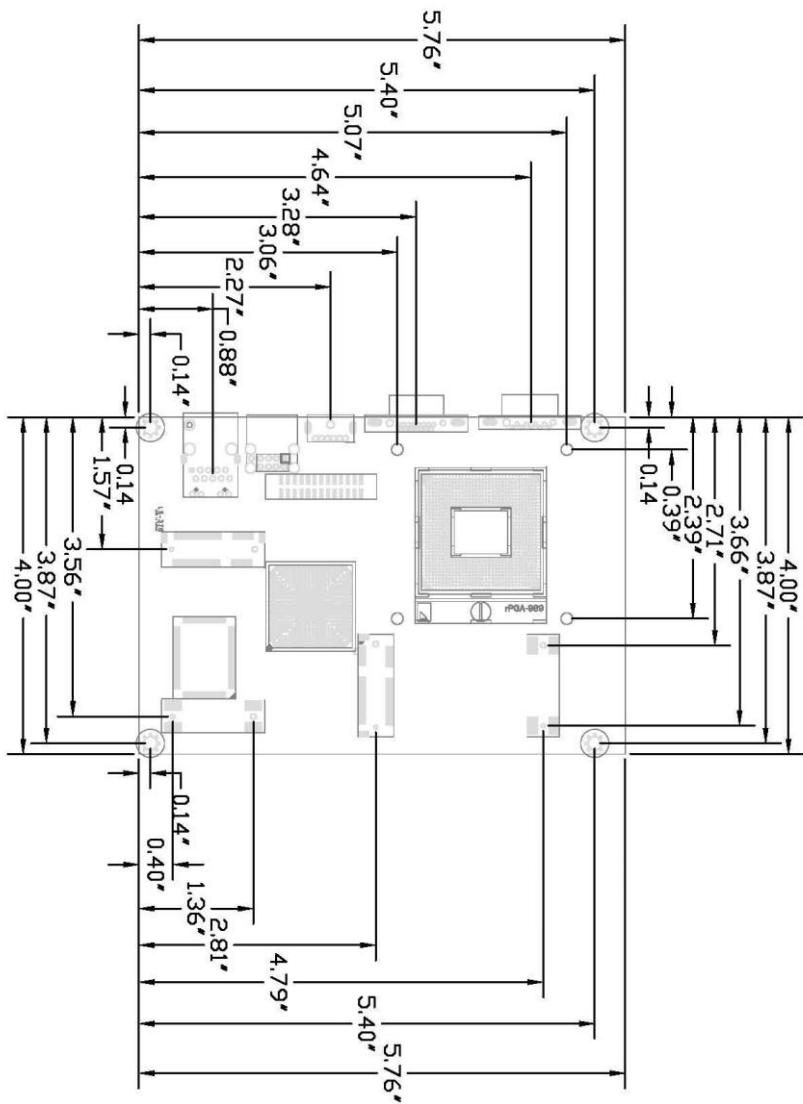

Unit: inch

1.4 <Block Diagram>

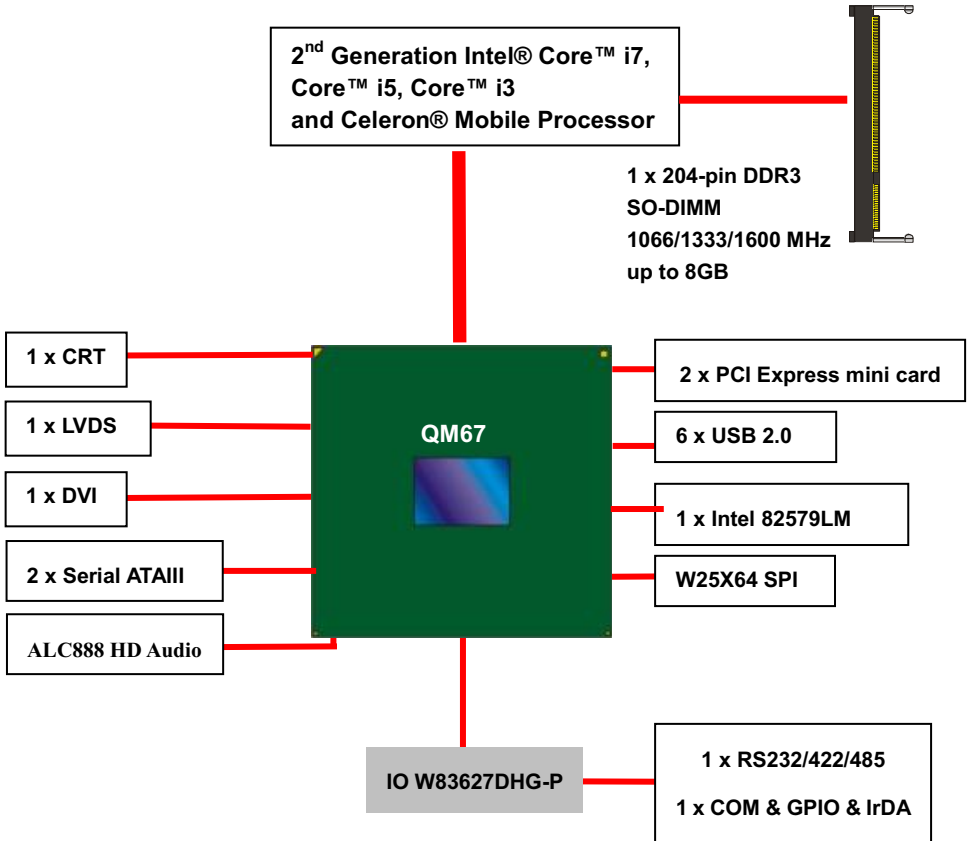

Chapter 2 <Hardware Setup>

2.1 <Connector Location>

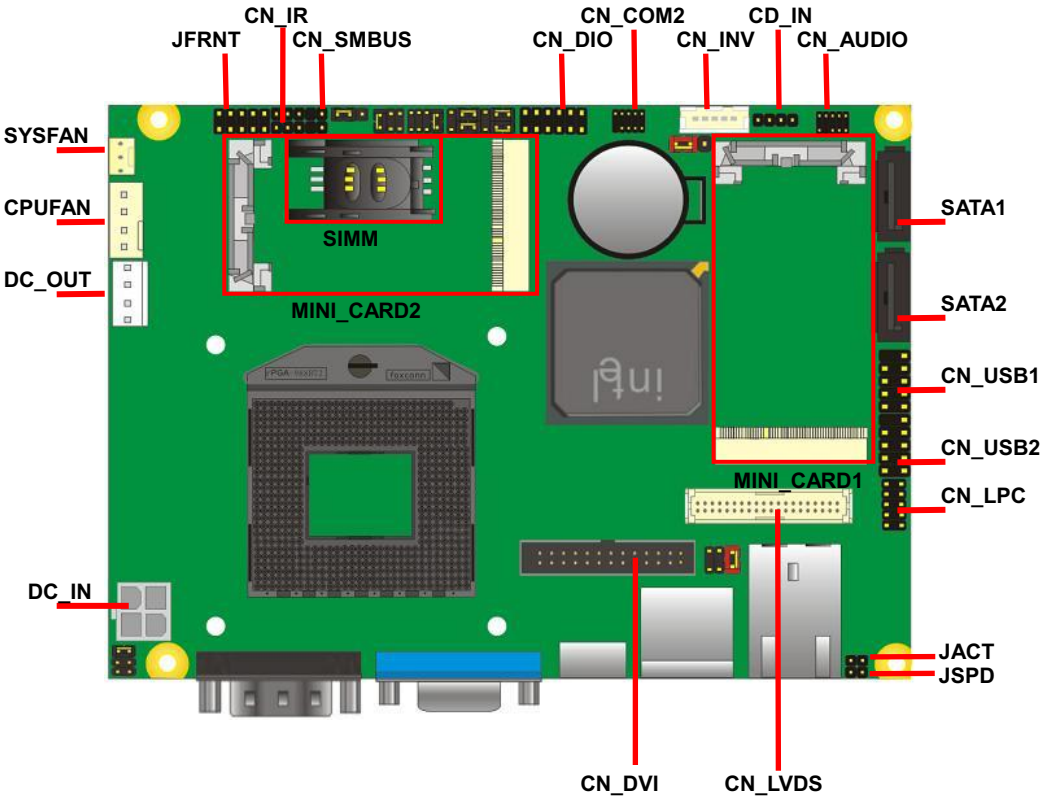

SO-DIMM

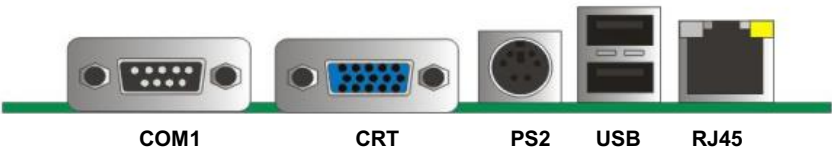
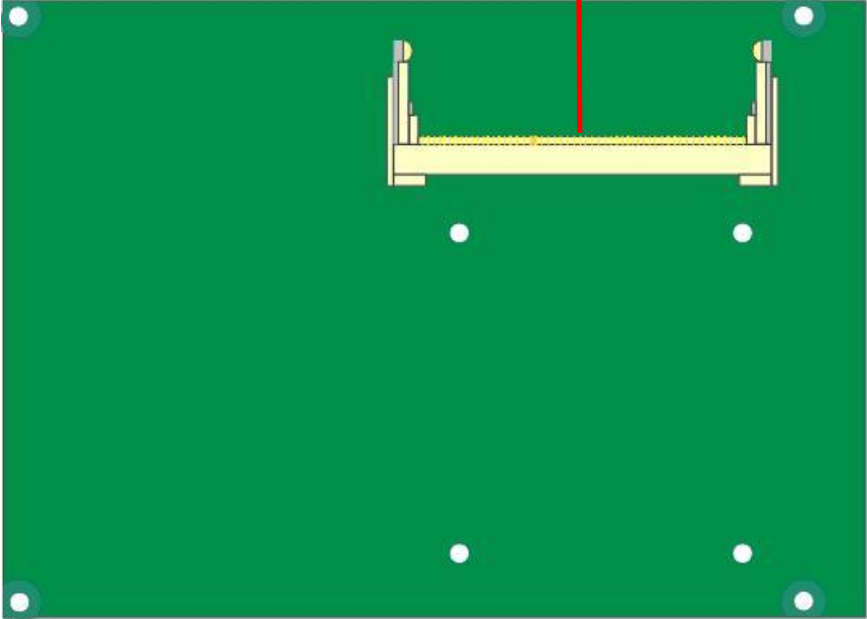

2.2 <Jumper Location & Reference>

Jumper	Function
JRTC	CMOS Operating/Clear Setting
JVLCD	Panel Voltage Setting
JAT	Power mode select
JP1	Com1 Voltage Setting (For Pin 9)
JP2	Com2 Voltage Setting (For Pin 9)
JCSEL1	CN_COM2 RS-232 RS422 RS485 Setting
JCSEL2	CN_IR IrDA Setting

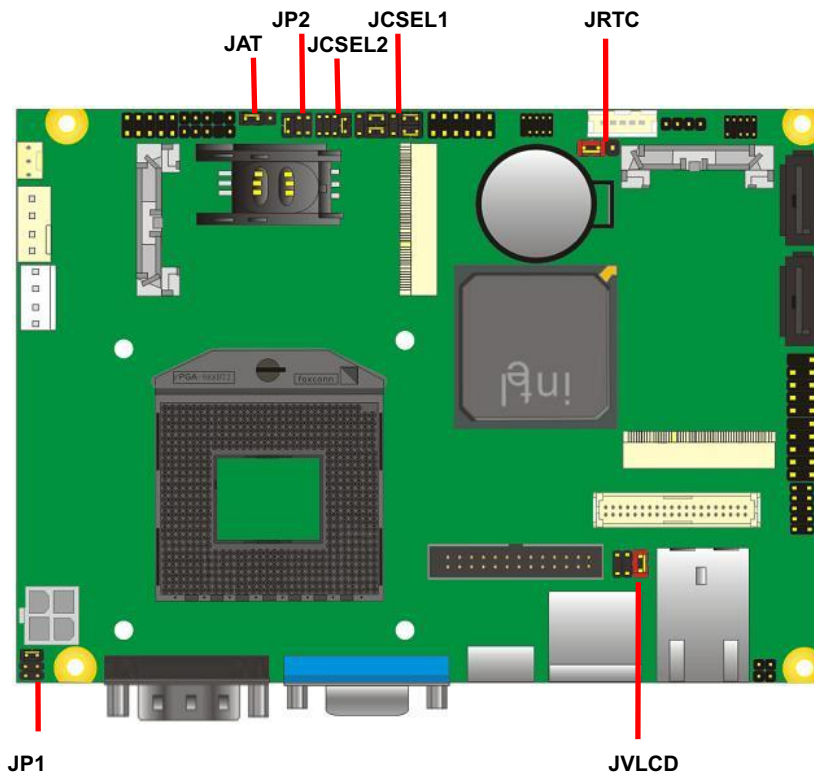

2.3 <Connector Reference>

2.3.1 <Internal Connectors>

Connector	Function	Remark
CPU	Socket rPGA988B for PGA988 CPU	
SO-DIMM	204 -pin DDR3 SO-DIMM socket	
SATA 1/2	7-pin Serial ATAIII connector	
DC_IN	DC 9~24V input connector	
DC_OUT	4-pin DC output connector	
CN_AUDIO	5 x 2-pin audio connector	
CD_IN	4-pin CD-ROM audio input connector	
CN_DIO	6 x 2-pin digital I/O connector	
CN_USB 1/2	5 x 2-pin USB connector	
CPUFAN	4-pin CPU cooler fan connector	
SYSFAN	3-pin system cooler fan connector	
CN_LVDS	20 x 2-pin LVDS connector	
CN_INV	5-pin LCD inverter connector	
CN_IR	5-pin IrDA connector	
CN_COM2	9-pin RS232/485/422	
CN_LPC	5 x 2-pin LPC connector	
JFRNT	10-pin front panel switch/indicator connector	
Mini-PCIE1/2	52-pin Mini-PCIE socket	
JAT	Power mode select	
JSPD	LAN Speed LED connector	
JACT	LAN Activity LED connector	

2.3.2 <External Connectors>

Connector	Function	Remark
COM1	DB9 Serial port connector	
CRT	DB15 VGA connector	
PS2	PS/2 keyboard and mouse connector	
USB	Dual USB 2.0 connector	
RJ45	RJ45 LAN connector	

2.4 <CPU and Memory Setup>

2.4.1 <CPU Setup>

The board comes with the socket rPGA988 for Intel **SandyBridge** Processor, Please follow the instruction to install the CPU properly.

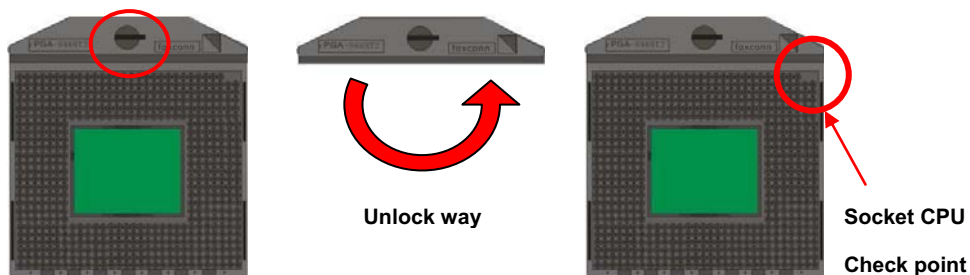

1. Use the flat-type screw drive to unlock the CPU socket

2. Follow the pin direction to install the processor on the socket

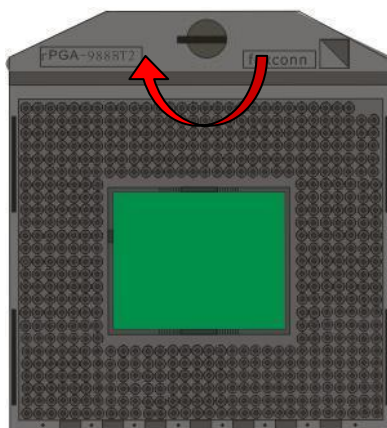

3. Lock the socket

2.4.2 <Memory Setup>

The board provides 204-pin DDR3 SO-DIMM to support 1066/1333/1600MHz DDR3 memory module up to 8GB.

Non-ECC, unbuffered memory supported only

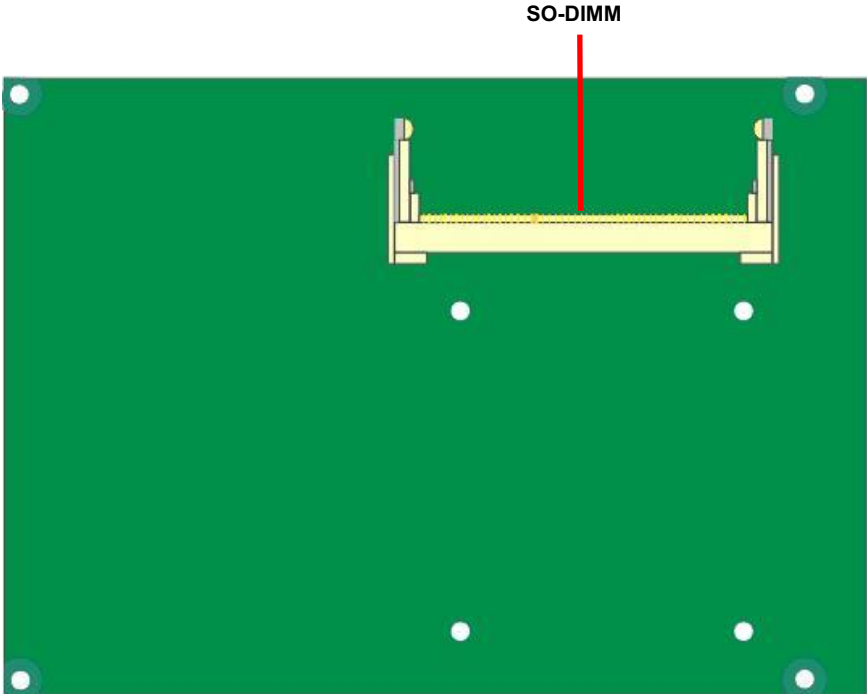

2.5 <CMOS & ATX Setup>

The board's data of CMOS can be setting in BIOS. If the board refuses to boot due to inappropriate CMOS settings, here is how to proceed to clear (reset) the CMOS to its default values.

Jumper: JRTC

Type: Onboard 3-pin jumper

JRTC	Mode
1-2	Clear CMOS
2-3	Normal Operation

Default setting: 2-3

Jumper: JAT

Type: onboard 3-pin jumper

JAT	Mode
1-2	AT Mode
2-3	ATX Mode

Default setting:2-3

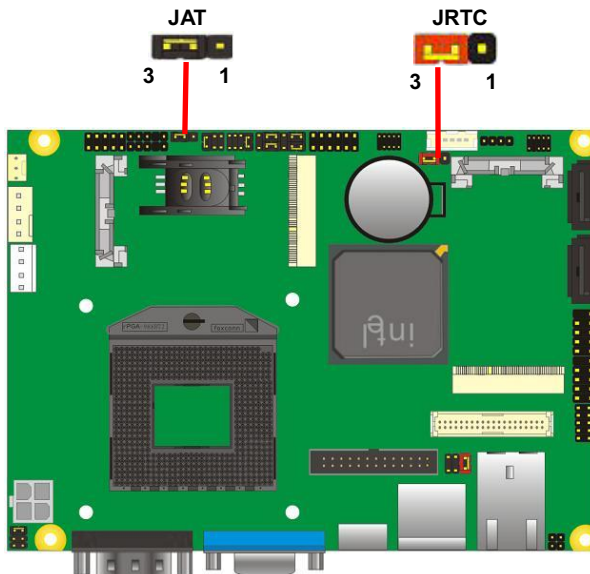

2.6 <Serial ATA Interface>

LS-378 has Two Serial ATA III(SATA Port1/2) interfaces with RAID function, the transfer rate of the Serial ATA III can be up to 600MB/s. Please go to <http://www.serialata.org/> for more about Serial ATA technology information.

1. Supports for up to RAID volumes on a single, two-hard drive RAID array.
2. Supports for two, two-hard drive RAID arrays on any of six Serial ATA ports.
3. Supports for Serial ATA ATAPI devices.
4. Supports for RAID spares and automatic rebuild.
5. Supports on RAID arrays, including NCQ and native hot plug.

For more information please visit Intel's official website.

For more about the system setup for Serial ATA, please check the chapter of SATA configuration.

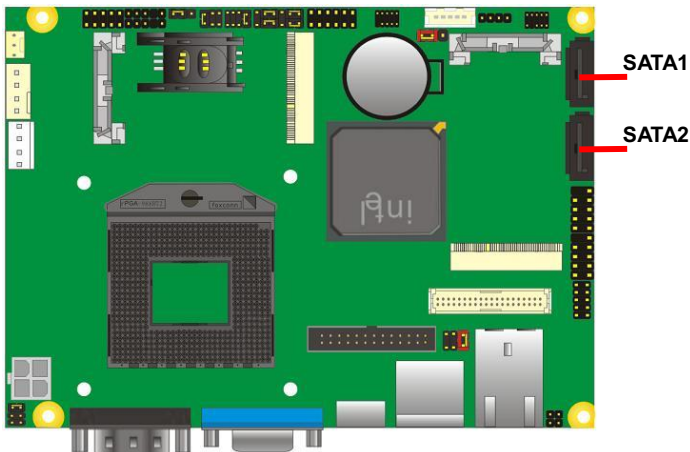

2.7 <Ethernet Interface>

The board integrates with one Intel 82579LM controllers, The Intel Gigabit Ethernet supports triple speed of 10/100/1000Base-T, with IEEE802.3 compliance.



2.8 <Onboard Display Interface>

Based on Intel **Sandy Bridge** CPU with built-in HD Graphic, the board provides one DB15 connector on rear external I/O port, one 40-pin LVDS interface with 5-pin LCD backlight inverter connector and provides 26-pin DVI interface.

The board provides dual display function with clone mode and extended desktop mode for CRT, LCD and DVI.

2.8.1 <Analog Display>

Please connect your CRT or LCD monitor with DB15 male connector to the onboard DB15 female connector on rear I/O port.



CRT

2.8.2 <Digital Display>

The board provides one 40-pin LVDS connector for 24-bit single/dual channel panels, supports up to 2048 x 1536 (UXGA) resolution, with one LCD backlight inverter connector and one jumper for panel voltage setting.

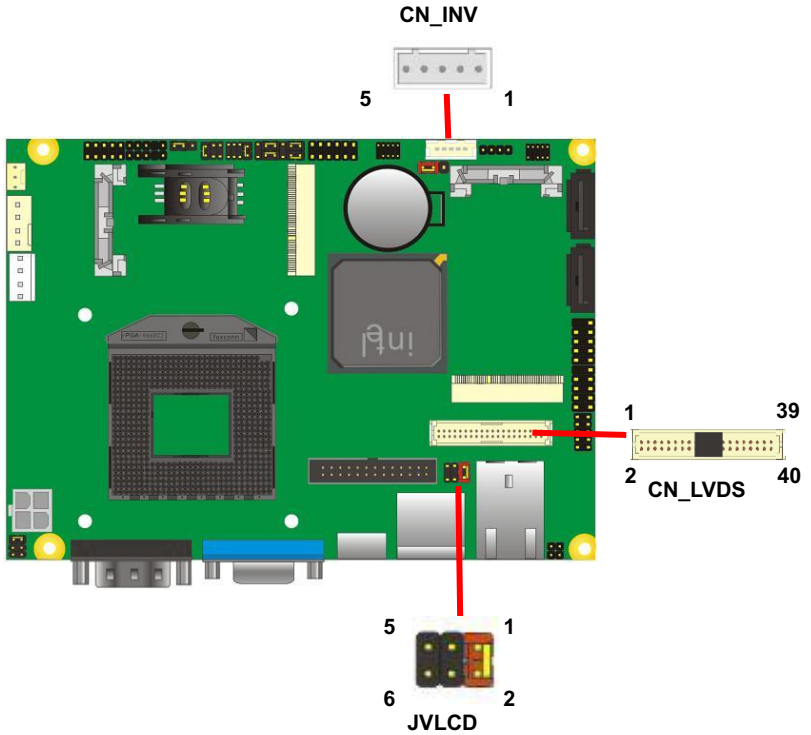

Effective patterns of connection: 1-2 / 3-4 / 5-6



Warning: others cause damages

Connector: **CN_INV**

Type: 5-pin LVDS Power Header

Pin	Description
1	+12V
2	Reserved (Note)
3	GND
4	GND
5	ENABKL

Note: Reserved for MB internal test
Please treat it as NC.

Connector: **JVLCD**

Type: 6-pin Power select Header

Pin	Description
1-2	LCDVCC (3.3V)
3-4	LCDVCC (5V)
5-6	LCDVCC (12V)

Default: 1-2

Connector: **CN_LVDS**

Type: onboard 40-pin connector for LVDS connector

Connector model:

E&T 3950-B40C-00R or similar (**HIROSE DF13-40DP-1.25V** compatible)

Pin	Signal	Pin	Signal
2	LCDVCC	1	LCDVCC
4	GND	3	GND
6	ATX0-	5	BTX0-
8	ATX0+	7	BTX0+
10	GND	9	GND
12	ATX1-	11	BTX1-
14	ATX1+	13	BTX1+
16	GND	15	GND
18	ATX2-	17	BTX2-
20	ATX2+	19	BTX2+
22	GND	21	GND
24	ACLK-	23	BTX3-
26	ACLK+	25	BTX3+
28	GND	27	GND
30	ATX3-	29	BCLK-
32	ATX3+	31	BCLK+
34	GND	33	GND
36	DDCPCLK	35	SMBCKL
38	DDCPDATA	37	SMBDATA
40	N/C	39	SPDIFO

LS-378 User's Manual

To setup the LCD, you need the component below:

1. A panel with LVDS interfaces.
2. An inverter for panel's backlight power.
3. A LCD cable and an inverter cable.

For the cables, please follow the pin assignment of the connector to make a cable, because every panel has its own pin assignment, so we do not provide a standard cable; please find a local cable manufacture to make cables.

LCD Installation Guide:

1. Preparing the **LS-378**, LCD panel and the **backlight inverter**.

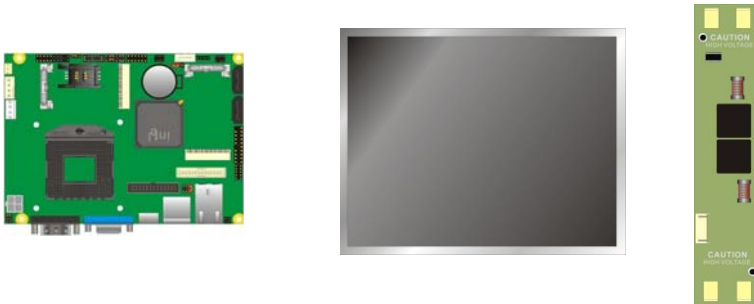

2. Please check the datasheet of the panel to see the voltage of the panel, and set the jumper **JVLCD** to +12V or +5V or +3.3V.
3. You would need a LVDS type cable.

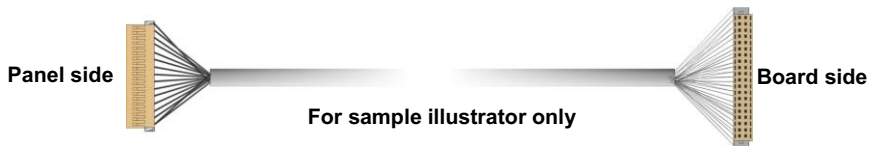

4. To connect all of the devices well.

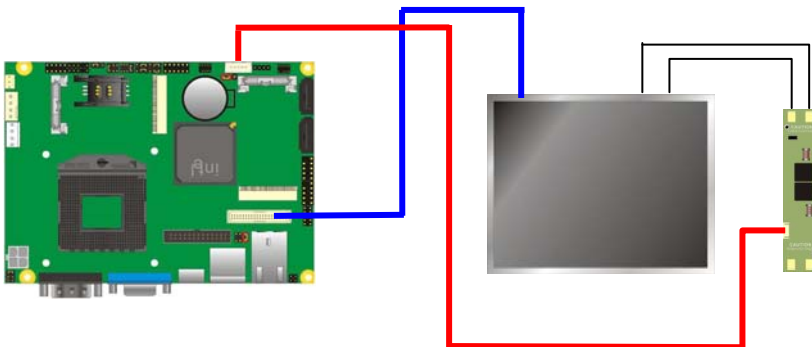

After setup the devices well, you need to select the LCD panel type in the BIOS.

The panel type mapping is list below:

BIOS panel type selection form (BIOS Version:1.0)			
Single / Dual channel		Single / Dual channel	
NO.	Output format	NO.	Output format
1	640 x 480	9	1680 x 1050
2	800 x 600	10	1920 x 1200
3	1024 x 768	11	1440 x 900
4	1280 x 1024	12	1600 x 900
5	1400 x 1050 Reduced Blanking	13	OEM Keep
6	1400 x 1050 non-Reduced Blanking	14	1280 x 800
7	1600 x 1200	15	1920 x 1080
8	1366 x 768	16	2048 x 1536

BIOS panel type selection form (BIOS Version:2.0)			
Single / Dual channel		Single / Dual channel	
NO.	Output format	NO.	Output format
1	640 x 480	9	1680 x 1050
2	800 x 600	10	1920 x 1200
3	1024 x 768	11	1440 x 900
4	1280 x 1024	12	1600 x 900
5	1400 x 1050 Reduced Blanking	13	800 x 480
6	1400 x 1050 non-Reduced Blanking	14	1280 x 800
7	1600 x 1200	15	1920 x 1080
8	1366 x 768	16	OEM Keep

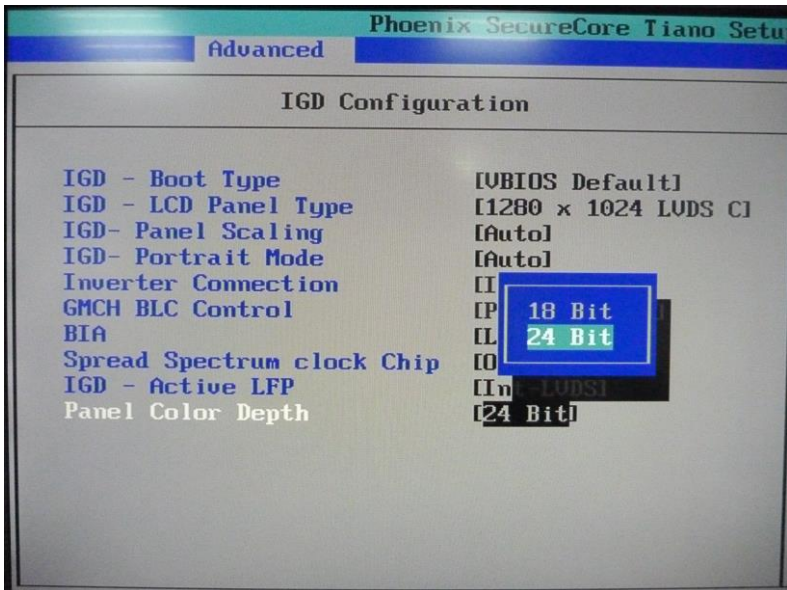

2.8.3 <DVI Interface>

Connector: **CN_DVI**

Connector type: 26-pin header connector (pitch = 2.00mm)

Pin Number	Assignment	Pin Number	Assignment
1	TX1+	2	TX1-
3	Ground	4	Ground
5	TXC+	6	TXC-
7	Ground	8	PVDD
9	N/C	10	N/C
11	TX2+	12	TX2-
13	Ground	14	Ground
15	TX0+	16	TX0-
17	N/C	18	HPDET
19	DDCDATA	20	DDCCLK
21	GND	22	N/C
23	N/C	24	N/C
25	N/C	26	N/C

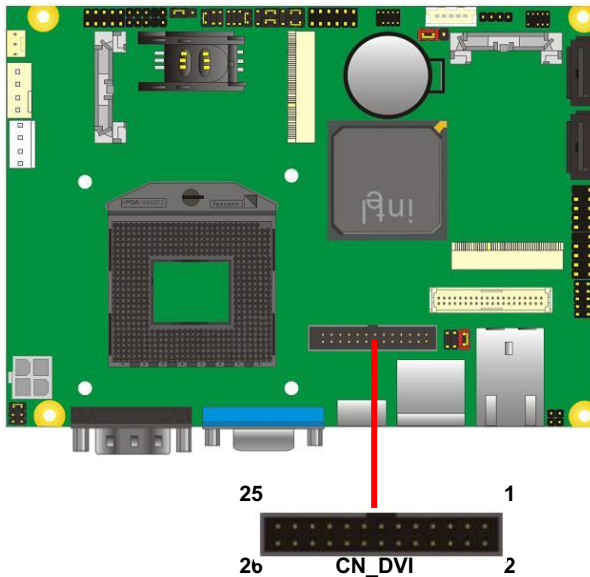

2.9 <Integrated Audio Interface>

The board integrates onboard audio interface with REALTEK ALC888 codec, with Intel next generation of audio standard as High Definition Audio, it offers more vivid sound and other advantages than former HD audio compliance.

The main specifications of ALC888 are:

- **High-performance DACs with 100dB S/N ratio**
- **2 DAC channels support 16/20/24-bit PCM format for 2 audio solution**
- **16/20/24-bit S/PDIF-OUT supports 44.1K/48K/96kHz sample rate**
- **Compatible with HD**
- **Meets Microsoft WHQL/WLP 2.0 audio requirements**

The board provides 2 channels audio phone jacks on rear I/O port, Line-in/MIC-in ports for front I/O panel through optional cable.

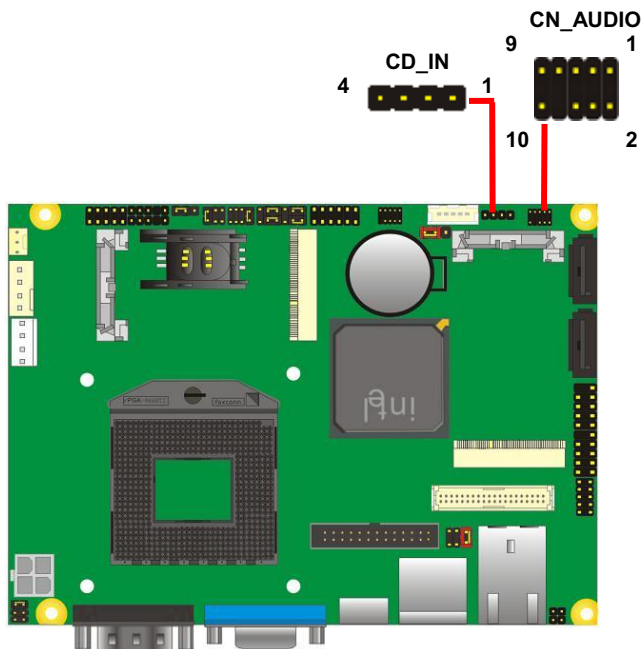

Connector: CN_AUDIO

Type: 10-pin (2 x 5) 1.27mm x 2.54mm-pitch header

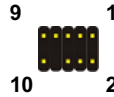

Pin	Description	Pin	Description
1	MIC_L	2	Ground
3	MIC_R	4	N/C
5	Speaker_R	6	MIC Detect
7	SENSE	8	N/C
9	Speaker_L	10	Speaker Detect

Connector: CDIN

Type: 4-pin header (pitch = 2.54mm)



Pin	Description
1	CD – Left
2	Ground
3	Ground
4	CD – Right

2.10 <USB Interface>

LS-378 integrates six USB2.0 ports. The specifications of USB2.0 are listed below:

Interface	USB2.0
Controller	Intel®QM67
Transfer Rate	Up to 480Mb/s
Voltage	5V

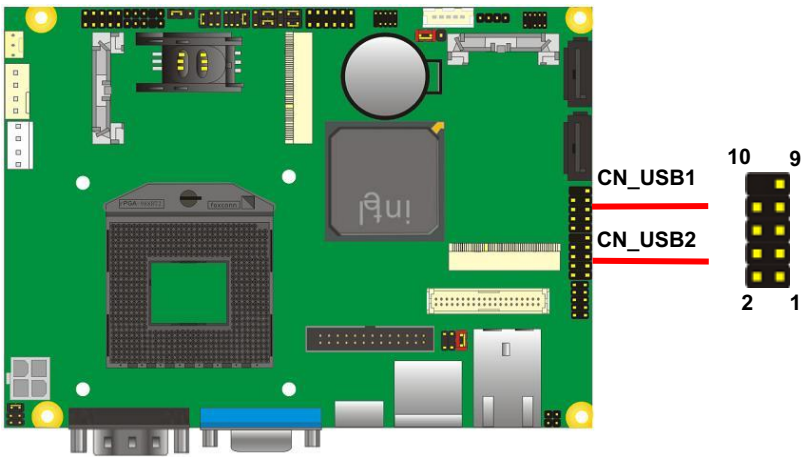

Connector: **CN_USB1/2**

Type: 10-pin (2 x 5) header (pitch = 2.54mm)

Pin	Description	Pin	Description
1	VCC	2	VCC
3	Data0-	4	Data1-
5	Data0+	6	Data1+
7	Ground	8	Ground
9	Ground	10	N/C

2.11 <Serial Port>

The board supports Three RS232 serial port and one jumper selectable RS232/422/485 serial ports. The jumper JCSEL1 & JCSEL2 can let you configure the communicating modes for COM2.



Connector: **COM1**

Type: 9-pin D-sub male connector on bracket for COM1/3

Pin	Description	Pin	Description
1	DCD	2	RXD
3	TXD	4	DTR
5	GND	6	DSR
7	RTS	8	CTS
9	RI	10	N/C

Connector: **COM2**

Type: 10-pin (5 x 2) 1.27mm x 2.54mm-pitch header for COM2

Pin	Description	Pin	Description
1	DCD/422TX-/485-	2	RXD/422TX+/485+
3	TXD/422RX+	4	DTR/422RX-
5	GND	6	DSR
7	RTS	8	CTS
9	RI	10	N/C

Setting RS-232 & RS-422 & RS-485 for COM2

Jumper: **JCSEL1,JCSEL2**

Type: 12-pin (6 x 2) & 8-pin (4 x 2) for set COM2 mode jumper

	RS232	RS485	RS422	IrDA
JCSEL1				
JCSEL2				

Default: RS232

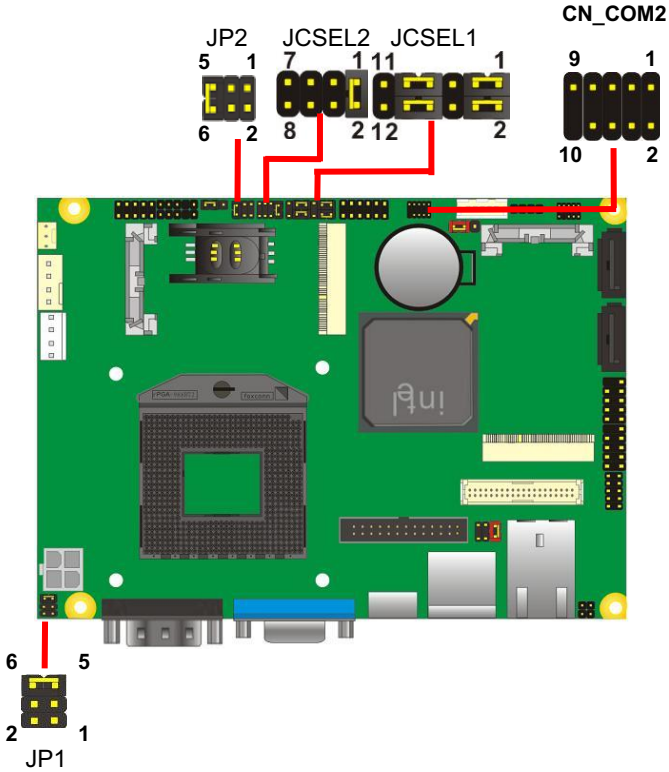

Jumper: **JP1/JP2 (COM1/2)**

Type: onboard 6-pin header

Power Mode	JP1/2/3/4
Pin 9 with 5V Power	1-2
Pin 9 with 12V Power	3-4
Standard COM port	5-6

Default setting: 5-6

2.12 <PCIE Mini Card and SIM Interface>

The board provides two PCIE mini card sockets and a SIM socket.

MINI_CARD1 is the first Mini-PCle slot for long size Mini-PCle cards.

Please be noted that the MPX-SDVOD card must be placed in this slot. The MPX-SDVOD card will not work if it is placed in other slot.

Please also be noted that this slot is the only slot for MPX-SDVOX card but a customized BIOS is needed for the MPX-SDVOX card. Please contact Commell for customized BIOS for your MPX-SDVOX card.

MINI_CARD2 is the second Mini-PCle slot for long size Mini-PCle cards.

However, if you are trying to use 3G Mini-PCle card with a SIM card then place your 3G Mini-PCle card in this slot and put your SIM card into the SIM card socket beneath this MINI_CARD2 support 3G PCIE Mini card with SIM.

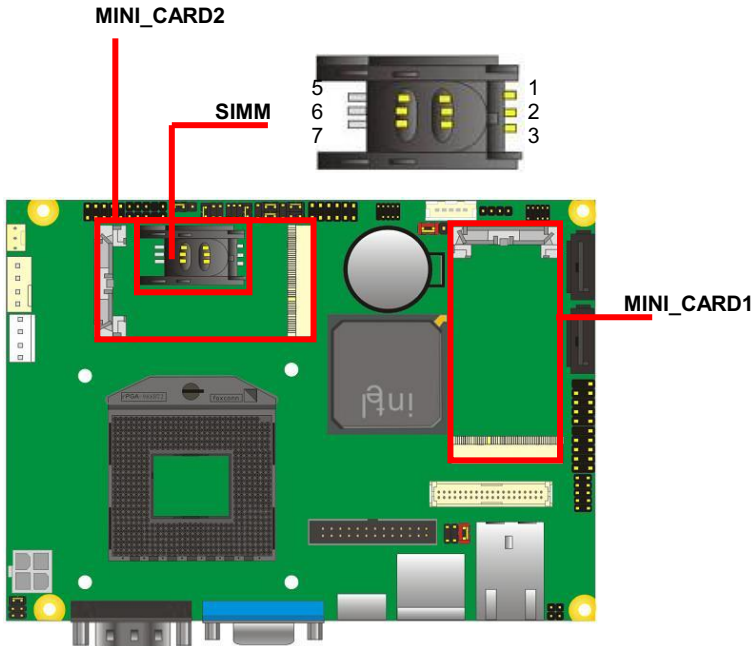

Connector: **SIMM**

Type: 6-pin SIM socket

Pin	Description	Pin	Description
1	SIMVCC	2	SIMRST
3	SIMCLK	4	NC
5	GND	6	SIMVPP
7	SIMDATA		

2.12.1 <SIM Setup>

Step 1.

SIM card holder is marked by circle.

Slide the cap toward OPEN direction.

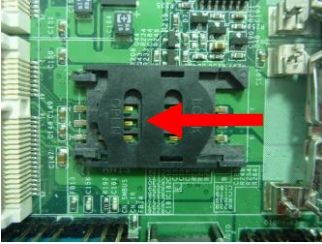

Step 2.

Make sure that the cap is now at the OPEN position.

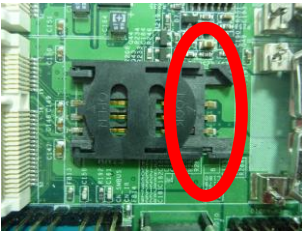

Step 3.

Flip the cap up for inserting a SIM card into.



Step 4.

Insert a SIM card as shown in the photo.

Be sure that the corner cut is on top and the golden pads are up.



Step 5.

Now, flip down the cap as shown in the photo.



Step 6.

Press down and slide the cap to the CLOSE position.

Be sure that the cap is tightly held with the socket

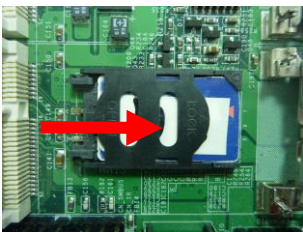

2.13 <GPIO and SMBUS Interface>

The board provides a programmable 8-bit digital I/O interface; you can use this general purpose I/O port for system control like POS or KIOSK.

Connector: **CN_DIO**

Type: 12-pin (6 x 2) header (pitch = 2.0mm)

Pin	Description	Pin	Description
1	Ground	2	Ground
3	GP10	4	GP14
5	GP11	6	GP15
7	GP12	8	GP16
9	GP13	10	GP17
11	5V	12	12V

Connector: **CN_SMBUS**

Type: 5-pin header for SMBUS Ports

Pin	Description
1	VCC
2	N/C
3	SMBDATA
4	SMBCLK
5	Ground

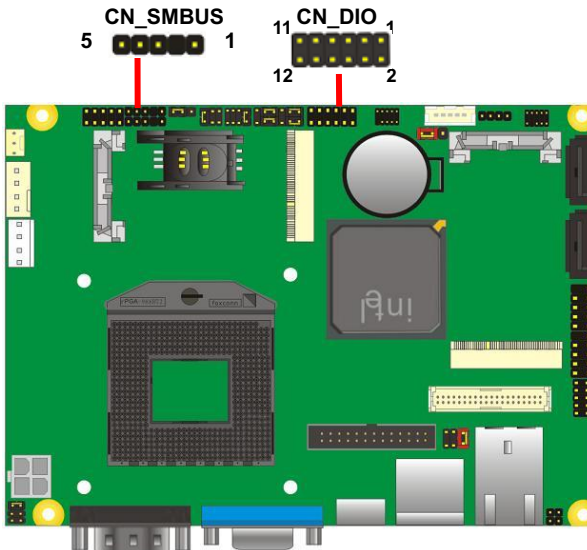

2.14 <Power Supply and Fan Interface >

2.14.1 <Power Input>

The board requires DC input with 4-pin header, the input voltage range is from 9V to 24V, for the input current, please take a reference of the power consumption report on appendix.

Connector: **DC_IN**

Type: 4-pin DC power connector

Pin	Description	Pin	Description
1	Ground	2	Ground
3	+9~+24V	4	+9~+24V

2.14.2 <Power Output>

Connector: **DC_OUT**

Type: 4-pin connector for +5V/+12V **output**

Pin	Description	Pin	Description	Pin	Description	Pin	Description
1	+12V	2	Ground	3	Ground	4	+5V

Note: Maximum output current 12V/3A, 5V/3A

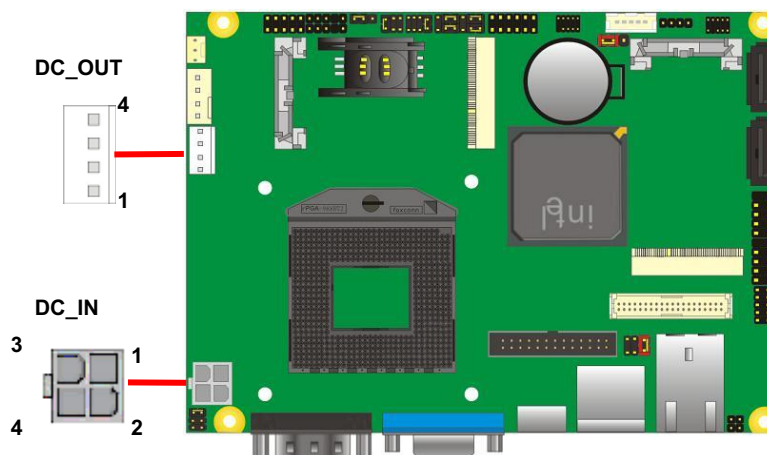

2.14.3 <Fan connector>

The board provides one **4-pin** fan connectors supporting smart fan for CPU cooler and one **3-pin** cooler fan connectors for system.

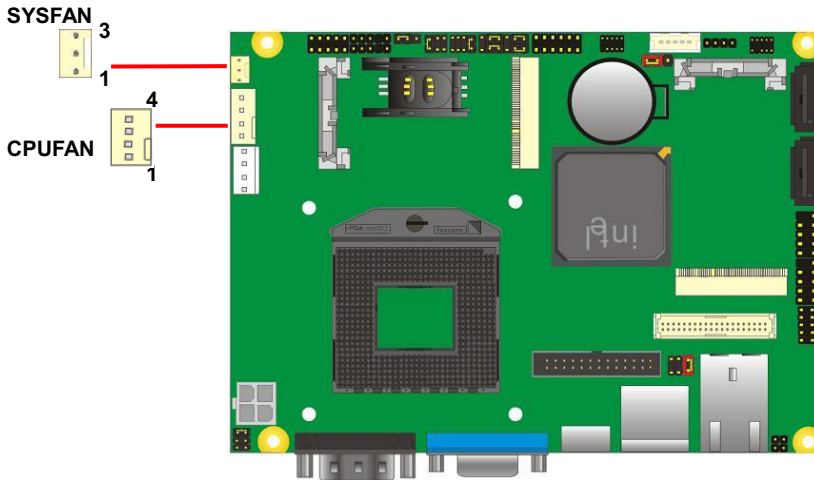

Connector: **CPUFAN**

Type: 4-pin fan wafer connector

Pin	Description	Pin	Description
1	Ground	2	+12V
3	Fan Speed Detection	4	Fan Control

Connector: **SYSFAN**

Type: 3-pin fan wafer connector

Pin	Description	Pin	Description	Pin	Description
1	Ground	2	+12V	3	Sense

2.15 <Switch and Indicator>

The **JFRNT** provides front control panel of the board, such as power button, reset and beeper, etc. Please check well before you connecting the cables on the chassis.

Connector: **JFRNT**

Type: onboard 10-pin (2 x 5) 2.54-pitch header

Function	Signal	PIN		Signal
Power	PWRBT-	1	2	PWRBT+
Speaker	SPK-	3	4	SPK+
HDD LED	HLED-	5	6	HLED+
Power LED	PWRLED-	7	8	PWRLED+
Reset	Reset+	9	10	Reset-

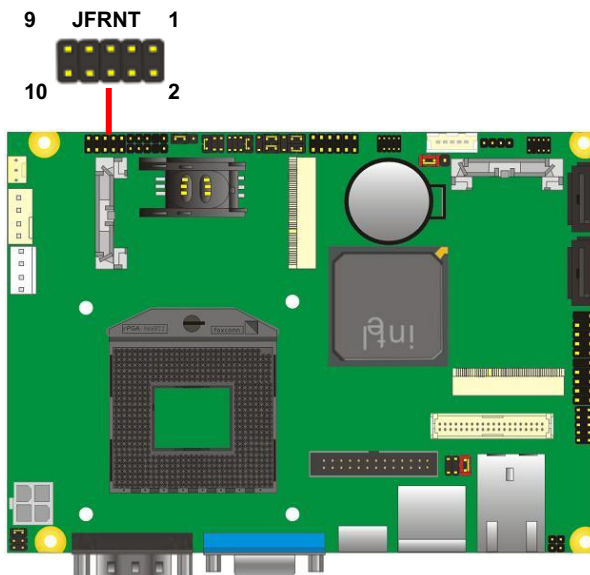

Chapter 3 <System Setup>

3.1 <Audio Configuration>

The board integrates Intel® QM67 with REALTEK® ALC888 codec. It can support 2-channel sound under system configuration. Please follow the steps below to setup your sound system.

1. Install REALTEK HD Audio driver.
2. Launch the control panel and Sound Effect Manager.

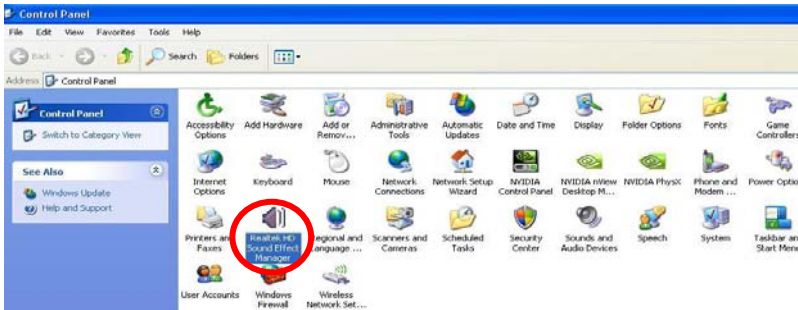

3. Select Speaker Configuration



3.2 <Display Properties Setting>

Based on Intel QM67 with HD Graphic, the board supports two DACs for display device as different resolution and color bit.

Please install the Intel Graphic Driver before you starting setup display devices.

1. Click right button on the desktop to lunch **display properties**

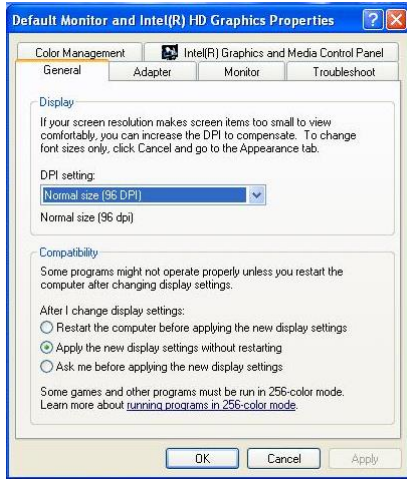

2. Click **Advanced** button for more specificity setup.

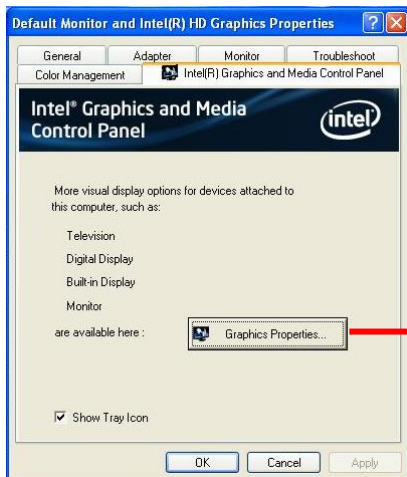

Click Graphics Properties... for advanced setup

3. This setup options can let you define each device settings.

Click **Monitor** to setup the CRT monitor for Resolution and Refresh Rate



Click **Intel® Dual Display Clone** to setup the dual display mode as same screen

3.3 <SATA configuration>

SATA Mode:

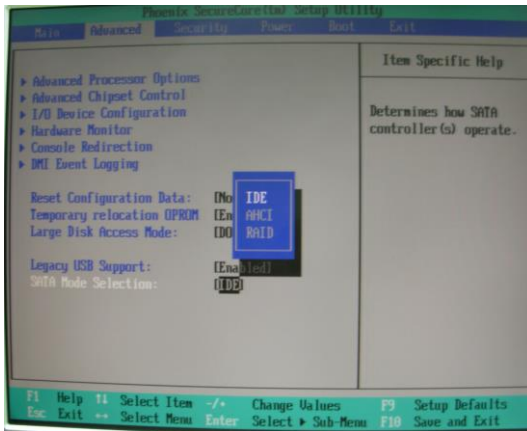

This option can let you select whether the Serial ATA hard drives would work under normal IDE mode or RAID mode. The RAID mode need more than one HDD is applied.

3.4 <SATA RAID Configuration>

The board integrates Intel® QM77 PCH with RAID function for Serial ATA drives, and supports the configurations below:

RAID 0 (Striping): Two hard drives operating as one drive for optimized data R/W performance. It needs two unused drives to build this operation.

RAID 1 (Mirroring): Copies the data from first drive to second drive for data security, and if one drive fails, the system would access the applications to the workable drive. It needs two unused drives or one used and one unused drive to build this operation. The second drive must be the same or larger size than first one.

If you need to install an operation system on the RAID set, please use the driver disk attached in the package when it informs you to obtain the RAID drivers.

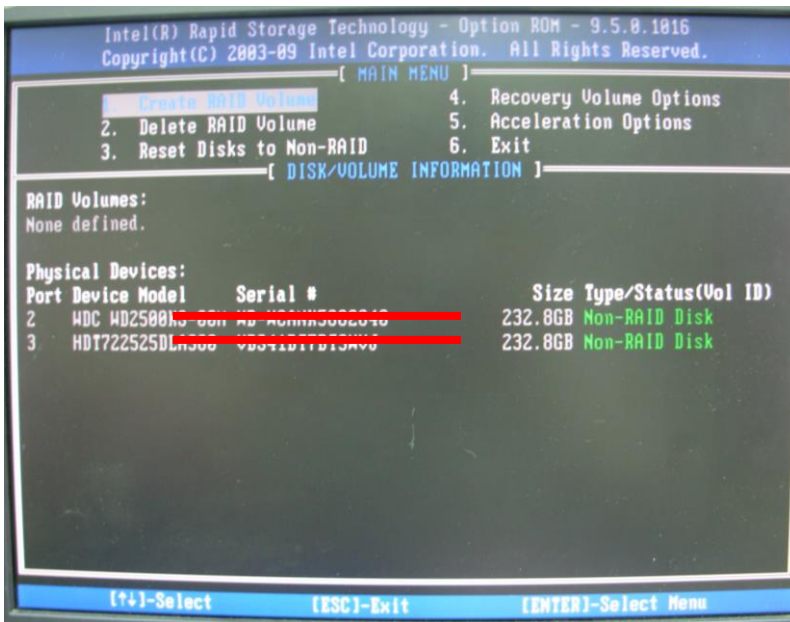

Chapter 4 <BIOS Setup>

The motherboard uses the Phoenix BIOS for the system configuration. The Phoenix BIOS in the single board computer is a customized version of the industrial standard BIOS for IBM PC AT-compatible computers. It supports Intel x86 and compatible CPU architecture based processors and computers. The BIOS provides critical low-level support for the system central processing, memory and I/O sub-systems.

The BIOS setup program of the single board computer let the customers modify the basic configuration setting. The settings are stored in a dedicated battery-backed memory, NVRAM, retains the information when the power is turned off. If the battery runs out of the power, then the settings of BIOS will come back to the default setting.

The BIOS section of the manual is subject to change without notice and is provided here for reference purpose only. The settings and configurations of the BIOS are current at the time of print, and therefore they may not be exactly the same as that displayed on your screen.

To activate CMOS Setup program, press key immediately after you turn on the system. The following message "Press DEL to enter SETUP" should appear in the lower left hand corner of your screen. When you enter the CMOS Setup Utility, the Main Menu will be displayed as **Figure 4-1**. You can use arrow keys to select your function, press <Enter> key to accept the selection and enter the sub-menu.

Figure 4-1 CMOS Setup Utility Main Screen

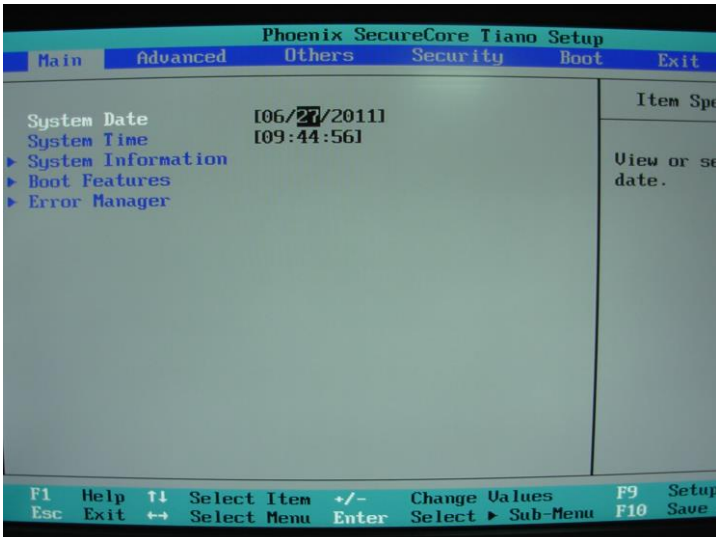

(This page is left for blank)

Appendix A <I/O Port Pin Assignment>

A.1 <Serial ATA Port>

Connector: **SATA1/2**

Type: 7-pin wafer connector

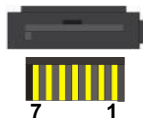

1	2	3	4	5	6	7
GND	RSATA_TXP1	RSATA_TXN1	GND	RSATA_RXN1	RSATA_RXP1	GND

A.2 <IrDA Port>

Connector: **CN_IR**

Type: 5-pin header for SIR Ports

JCSEL1 must jump to "SIR"

Pin	Description
1	VCC
2	N/C
3	IRRX
4	Ground
5	IRTX



A.3 <VGA Port>

Connector: **CRT**

Type: 15-pin D-sub female connector on bracket

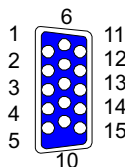

Pin	Description	Pin	Description	Pin	Description
1	RED	6	Ground	11	N/C
2	GREEN	7	Ground	12	DDCDA
3	BLUE	8	Ground	13	HSYNC
4	N/C	9	N/C	14	VSYNC
5	Ground	10	Ground	15	DDCCLK

A.4 <LAN Port>

Connector: **RJ45**

Type: RJ45 connector with LED on bracket

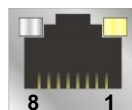

Pin	1	2	3	4	5	6	7	8
Description	MI0+	MI0-	MI1+	MI2+	MI2-	MI1-	MI3+	MI3-

A.5 <LAN LED Port>

Connector: **JSPD1/2**

Type: 5-pin header for LAN Speed LED connector

When Lan speed 10/100Mbps

Pin	Description
1	LED-
2	LED+

When Lan speed 1Gbps

Pin	Description
1	LED+
2	LED-

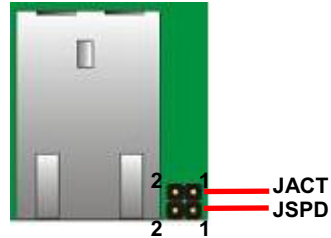

Connector: **JATC1/2**

Type: 5-pin header for LAN Activity LED connector

Pin	Description
1	LED-
2	LED+

A.6 <LPC Port>

Connector: **CN_LPC**

Type: 10-pin header for LPC Port



Pin	Description	Pin	Description
1	LPC_CLK	2	RESET-
3	LFRAME-	4	LAD3
5	LAD2	6	LAD1
7	LAD1	8	+3.3V
9	Ground	10	Ground

Appendix B <Flash BIOS>

B.1 <Flash Tool>

The board is based on Phoenix BIOS and can be updated easily by the BIOS auto flash tool. You can download the tool online at the address below:

<http://www.commell.com.tw/Support/Product%20Technical%20Support/LS-378.htm>

File name of the tool is "Phlash.exe", it's the utility that can write the data into the BIOS flash ship and update the BIOS.

B.2 <Flash BIOS Procedure>

1. Please make a bootable floppy disk.
2. Get the last .bin files you want to update and copy it into the disk.
3. Copy Phlash.exe to the disk.
4. Power on the system and flash the BIOS.
(Example: C:/Pflash XXX.bin /bbl /cvar /sa)
5. Restart the system.





















Any question about the BIOS re-flash please contact your distributors or visit the web-site at below:

<http://www.commell.com.tw/Support/Support.htm>

Appendix C <System Resources>

C.1 <I/O Port Address Map>

Input/output (IO)	
[00000000 - 0000001F]	Direct memory access controller
[00000000 - 00000CF7]	PCI bus
[00000020 - 00000021]	Programmable interrupt controller
[00000024 - 00000025]	Programmable interrupt controller
[00000028 - 00000029]	Programmable interrupt controller
[0000002C - 0000002D]	Programmable interrupt controller
[0000002E - 0000002F]	Motherboard resources
[00000030 - 00000031]	Programmable interrupt controller
[00000034 - 00000035]	Programmable interrupt controller
[00000038 - 00000039]	Programmable interrupt controller
[0000003C - 0000003D]	Programmable interrupt controller
[00000040 - 00000043]	System timer
[0000004E - 0000004F]	Motherboard resources
[00000050 - 00000053]	System timer
[00000060 - 00000060]	Standard 101/102-Key or Microsoft Natural PS/2 Keyboard
[00000061 - 00000061]	Motherboard resources
[00000063 - 00000063]	Motherboard resources
[00000064 - 00000064]	Standard 101/102-Key or Microsoft Natural PS/2 Keyboard
[00000065 - 00000065]	Motherboard resources
[00000067 - 00000067]	Motherboard resources
[00000070 - 00000070]	Motherboard resources
[00000070 - 00000077]	System CMOS/real time clock
[00000080 - 00000080]	Motherboard resources
[00000081 - 00000091]	Direct memory access controller
[00000092 - 00000092]	Motherboard resources
[00000093 - 0000009F]	Direct memory access controller
[000000A0 - 000000A1]	Programmable interrupt controller
[000000A4 - 000000A5]	Programmable interrupt controller
[000000A8 - 000000A9]	Programmable interrupt controller
[000000AC - 000000AD]	Programmable interrupt controller
[000000B0 - 000000B1]	Programmable interrupt controller
[000000B2 - 000000B3]	Motherboard resources
[000000B4 - 000000B5]	Programmable interrupt controller
[000000B8 - 000000B9]	Programmable interrupt controller
[000000BC - 000000BD]	Programmable interrupt controller
[000000C0 - 000000DF]	Direct memory access controller
[000000F0 - 000000F0]	Numeric data processor
[00000274 - 00000277]	ISAPNP Read Data Port
[00000279 - 00000279]	ISAPNP Read Data Port
[000002F8 - 000002FF]	Communications Port (COM2)
[000003B0 - 000003BB]	Intel(R) HD Graphics Family
[000003C0 - 000003DF]	Intel(R) HD Graphics Family
[000003F8 - 000003FF]	Communications Port (COM1)
[00000400 - 00000453]	Motherboard resources
[00000454 - 00000457]	Motherboard resources
[00000458 - 0000047F]	Motherboard resources
[000004D0 - 000004D1]	Programmable interrupt controller
[00000500 - 0000057F]	Motherboard resources
[00000680 - 0000069F]	Motherboard resources
[00000A79 - 00000A79]	ISAPNP Read Data Port



	[00000D00 - 0000FFFF] PCI bus
	[00001000 - 0000100F] Motherboard resources
	[0000164E - 0000164F] Motherboard resources
	[00002000 - 0000203F] Intel(R) HD Graphics Family
	[00002060 - 0000207F] Intel(R) 82579LM Gigabit Network Connection
	[00002080 - 0000208F] Intel(R) 6 Series/C200 Series Chipset Family 2 port Serial ATA Storage Controller - 1C09
	[00002090 - 0000209F] Intel(R) 6 Series/C200 Series Chipset Family 2 port Serial ATA Storage Controller - 1C09
	[000020A0 - 000020AF] Intel(R) 6 Series/C200 Series Chipset Family 4 port Serial ATA Storage Controller - 1C01
	[000020B0 - 000020BF] Intel(R) 6 Series/C200 Series Chipset Family 4 port Serial ATA Storage Controller - 1C01
	[000020C0 - 000020C7] Intel(R) 6 Series/C200 Series Chipset Family 2 port Serial ATA Storage Controller - 1C09
	[000020C8 - 000020CF] Intel(R) 6 Series/C200 Series Chipset Family 2 port Serial ATA Storage Controller - 1C09
	[000020D0 - 000020D7] Intel(R) 6 Series/C200 Series Chipset Family 4 port Serial ATA Storage Controller - 1C01
	[000020D8 - 000020DF] Intel(R) 6 Series/C200 Series Chipset Family 4 port Serial ATA Storage Controller - 1C01
	[000020E0 - 000020E3] Intel(R) 6 Series/C200 Series Chipset Family 2 port Serial ATA Storage Controller - 1C09
	[000020E4 - 000020E7] Intel(R) 6 Series/C200 Series Chipset Family 2 port Serial ATA Storage Controller - 1C09
	[000020E8 - 000020EB] Intel(R) 6 Series/C200 Series Chipset Family 4 port Serial ATA Storage Controller - 1C01
	[000020EC - 000020EF] Intel(R) 6 Series/C200 Series Chipset Family 4 port Serial ATA Storage Controller - 1C01
	[0000EFA0 - 0000EFBF] Intel(R) 6 Series/C200 Series Chipset Family SMBus Controller - 1C22
	[0000FFFF - 0000FFFF] Motherboard resources
	[0000FFFF - 0000FFFF] Motherboard resources

C.2 <Memory Address Map>



















Memory Address Range	Device Name
[000A0000 - 000BFFFF]	Intel(R) HD Graphics Family
[000A0000 - 000BFFFF]	PCI bus
[20000000 - 201FFFFF]	System board
[40000000 - 401FFFFF]	System board
[DFA00000 - FEAFFFFF]	PCI bus
[E0000000 - EFFFFFFF]	Intel(R) HD Graphics Family
[F0000000 - F03FFFFF]	Intel(R) HD Graphics Family
[F0400000 - F041FFFF]	Intel(R) 82579LM Gigabit Network Connection
[F0420000 - F0423FFF]	Microsoft UAA Bus Driver for High Definition Audio
[F0424000 - F04240FF]	Intel(R) 6 Series/C200 Series Chipset Family SMBus Controller - 1C22
[F0425000 - F042500F]	Intel(R) 6 Series/C200 Series Management Engine Interface - 1C3A
[F0428000 - F04283FF]	Intel(R) 6 Series/C200 Series Chipset Family USB Enhanced Host Controller - 1C26
[F0429000 - F04293FF]	Intel(R) 6 Series/C200 Series Chipset Family USB Enhanced Host Controller - 1C2D
[F042A000 - F042AFFF]	Intel(R) 82579LM Gigabit Network Connection
[F8000000 - FBFFFFFF]	Motherboard resources
[FED00000 - FED003FF]	High precision event timer
[FED10000 - FED17FFF]	Motherboard resources
[FED18000 - FED18FFF]	Motherboard resources
[FED19000 - FED19FFF]	Motherboard resources
[FED1C000 - FED1FFFF]	Motherboard resources
[FED20000 - FED3FFFF]	Motherboard resources
[FED40000 - FED44FFF]	PCI bus
[FED45000 - FED8FFFF]	Motherboard resources
[FED90000 - FED93FFF]	Motherboard resources
[FEE00000 - FEEFFFFFFF]	Motherboard resources
[FF000000 - FFFFFFFF]	Intel(R) 82802 Firmware Hub Device
[FF000000 - FFFFFFFF]	Motherboard resources

C.3 <System DMA & IRQ Resources>

DMA:

-  Direct memory access (DMA)
-  4 Direct memory access controller

IRQ:

-  Interrupt request (IRQ)
 -  (ISA) 0 System timer
 -  (ISA) 1 Standard 101/102-Key or Microsoft Natural PS/2 Keyboard
 -  (ISA) 3 Communications Port (COM2)
 -  (ISA) 4 Communications Port (COM1)
 -  (ISA) 8 System CMOS/real time clock
 -  (ISA) 9 Microsoft ACPI-Compliant System
 -  (ISA) 12 PS/2 Compatible Mouse
 -  (ISA) 13 Numeric data processor
 -  (PCI) 9 Intel(R) 6 Series/C200 Series Chipset Family SMBus Controller - 1C22
 -  (PCI) 10 Intel(R) 6 Series/C200 Series Management Engine Interface - 1C3A
 -  (PCI) 16 Intel(R) 6 Series/C200 Series Chipset Family PCI Express Root Port 1 - 1C10
 -  (PCI) 16 Intel(R) 6 Series/C200 Series Chipset Family USB Enhanced Host Controller - 1C2D
 -  (PCI) 16 Intel(R) HD Graphics Family
 -  (PCI) 19 Intel(R) 6 Series/C200 Series Chipset Family 2 port Serial ATA Storage Controller - 1C09
 -  (PCI) 19 Intel(R) 6 Series/C200 Series Chipset Family 4 port Serial ATA Storage Controller - 1C01
 -  (PCI) 20 Intel(R) 82579LM Gigabit Network Connection
 -  (PCI) 22 Microsoft UAA Bus Driver for High Definition Audio
 -  (PCI) 23 Intel(R) 6 Series/C200 Series Chipset Family USB Enhanced Host Controller - 1C26

Appendix D <Programming GPIO's>

The GPIO can be programmed with the MSDOS debug program using simple IN/OUT commands. The following lines show an example how to do this.

```

GPIO0.....GPIO7  bit0.....bit7
-o 2E 87           ;enter configuration
-o 2E 87
-o 2E 07
-o 2F 09           ;enable GPIO function
-o 2E 30
-o 2F 02           ;enable GPIO configuration
-o 2E F0
-o 2F xx           ;set GPIO as input/output; set '1' for input,'0'for
output
-o 2E F1
-o 2F xx           ;if set GPIO's as output,in this register its value can
be set

```

Optional :

```

-o 2E F2
-o 2F xx           ; Data inversion register ; '1' inverts the current valus
of the bits ,'0' leaves them as they are
-o 2E 30
-o 2F 01           ; active GPIO's

```

For further information, please refer to Winbond W83627DHG datasheet.

Appendix E <Programming Watchdog Timer >

The watchdog timer makes the system auto-reset while it stops to work for a period.

The integrated watchdog timer can be setup as system reset mode by program.

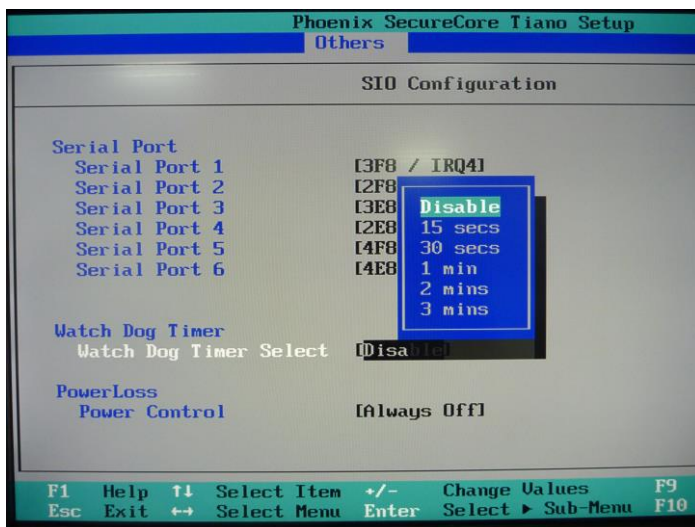

Timeout Value Range

- 1 to 255
- Second or Minute

Program Sample

Watchdog timer setup as system reset with 5 second of timeout

```

2E, 87
2E, 87
2E, 07
2F, 08      Logical Device 8
2E, 30      Activate
2F, 01
2E, F5      Set as Second*
2F, 00
2E, F6      Set as 5
2F, 05

```

* Minute: bit 3 = 1; Second: bit 3 = 0

You can select Timer setting in the BIOS, after setting the time options, the system will reset according to the period of your selection.

Contact Information

Any advice or comment about our products and service, or anything we can help you please don't hesitate to contact with us. We will do our best to support you for your products, projects and business.

Taiwan Commate Computer Inc.

Address	19F., No.94, Sec. 1, Xintai 5th Rd., Xizhi Dist., New Taipei City 22102, Taiwan
TEL	+886-2-26963909
FAX	+886-2-26963911
Website	http://www.commell.com.tw
E-Mail	info@commell.com.tw (General Information) tech@commell.com.tw (Technical Support)

Commell is a brand name of Taiwan commate computer Inc.