

HS-B70

PICMG 1.3 Half-size CPU Card

User's Manual

Edition 1.2

2014/3/13

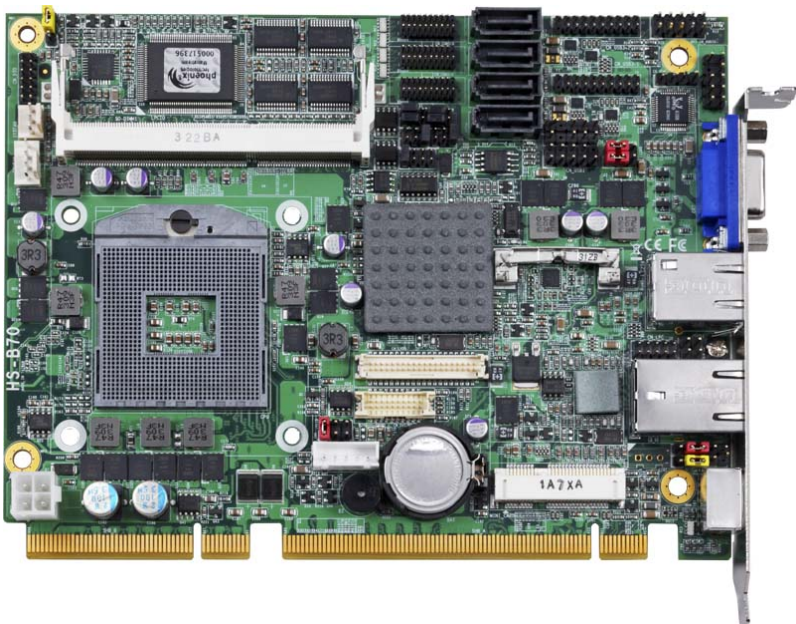

Copyright

Copyright 2013, all rights reserved. This document is copyrighted and all rights are reserved. The information in this document is subject to change without prior notice to make improvements to the products.

This document contains proprietary information and protected by copyright. No part of this document may be reproduced, copied, or translated in any form or any means without prior written permission of the manufacturer.

All trademarks and/or registered trademarks contains in this document are property of their respective owners.

Disclaimer

The company shall not be liable for any incidental or consequential damages resulting from the performance or use of this product.

The company does not issue a warranty of any kind, express or implied, including without limitation implied warranties of merchantability or fitness for a particular purpose. The company has the right to revise the manual or include changes in the specifications of the product described within it at any time without notice and without obligation to notify any person of such revision or changes.

Trademark

All trademarks are the property of their respective holders.

Any questions please visit our website at <http://www.commell.com.tw>

Packing List:

Please check the package content before you starting using the board.

Hardware:

HS-B70 PICMG 1.3 Half-size CPU Card x 1

Cable Kit:



SATA Cable x 2
(OALSATA3-L) (1040529)



PS/2 Keyboard & Mouse Cable x 1
(OALPS2/MKN) (1040551)



Dual COM PORT cable x 1
(OALES-BKU2) (1040087)



Audio Cable x 1
(OALPJ-HD) (1040120)



CPU Cooler x 1
(OHS-P-M-H) (1190058)

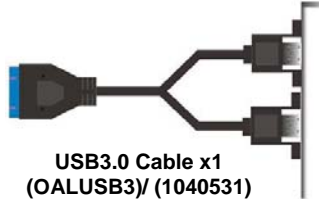

USB3.0 Cable x1
(OALUSB3) (1040531)

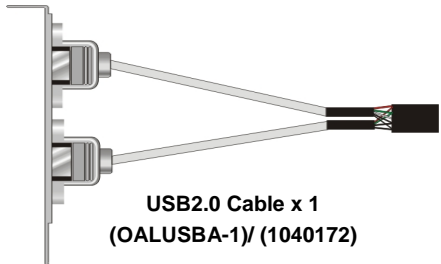

USB2.0 Cable x 1
(OALUSBA-1) (1040172)



DVI module with bracket x 1
(BADPDVIP_A&OALDVI-DF13)
(4120008021 & 1040483)

Printed Matters:

Driver CD (Including User's Manual) x 1

Index

Chapter 1 <Introduction>	6
1.1 <Product Overview>.....	6
1.2 <Product Specification>.....	7
1.3 <Mechanical Drawing>.....	9
1.4 <Block Diagram>.....	10
Chapter 2 <Hardware Setup>	11
2.1 <Connector Location>.....	11
2.2 <Jumper Location & Reference>.....	12
2.3 <Connector Reference>.....	13
2.3.1 <Internal Connectors>.....	13
2.3.2 <External Connectors>.....	13
2.4 <CPU and Memory Setup>.....	14
2.4.1 <CPU Setup>.....	14
2.4.2 <Memory Setup>.....	15
2.5 <CMOS & ATX Setup>.....	16
2.6 <Serial ATA Interface>.....	17
2.7 <Ethernet Interface>.....	18
2.8 <Onboard Display Interface>.....	19
2.8.1 <Analog Display>.....	19
2.8.2 <Digital Display>.....	20
2.8.3 <DVI Interface>.....	24
2.9 <Integrated Audio Interface>.....	25
2.10 <USB Interface>.....	27
2.11 <Serial Port>.....	29
2.12 <PCIE Mini Card >.....	31
2.13 <GPIO and SMBUS Interface>.....	32
2.14 <Power Supply and Fan Interface >.....	33
2.14.1 <Power Input>(need Backplane).....	33
2.14.2 <Fan connector>.....	34

2.15 <Switch and Indicator>	35
Chapter 3 <System Setup>	36
3.1 <Audio Configuration>	36
3.2 <Display Properties Setting>	37
3.3 <SATA configuration>	39
3.4 <SATA RAID Configuration>	40
Chapter 4 <BIOS Setup>	42
Appendix A <I/O Port Pin Assignment>	44
A.1 <Serial ATA Port>	44
A.2 <IrDA Port>.....	44
A.3 <VGA Port>	44
A.4 <LAN Port>.....	44
A.5 <LAN LED Port>.....	45
Appendix B <Flash BIOS>	46
B.1 <Flash Tool>	46
B.2 <Flash BIOS Procedure>	46
Appendix C <Programming GPIO's >	47
Appendix D <Programming Watchdog Timer >.....	48
Contact Information	49

(This page is left for blank)

Chapter 1 <Introduction>

1.1 <Product Overview>

HS-B70 the 3rd Generation Intel of the PICMG 1.3 Half-size CPU Card, supports 3rd Generation Intel® Core™ i7, Core™ i5, Core™ i3 Mobile Processor and features Intel QM77 chipset, integrated HD Graphics, DDR3 memory, REALTEK High Definition Audio, Serial ATA with RAID function for a system and Intel Gigabit LAN.

Intel Ivy Bridge Processor

The 3rd Generation Intel® Core™ processor family mobile is the next generation of 64-bit, multi-core mobile processor built on 22- nanometer process technology. Based on a new micro-architecture.

New features for Intel QM77 chipset

The board integrates Intel QM77 chipset, supports integrated HD Graphics, built-in high speed mass storage interface of Serial ATA interface with RAID function, High Definition Audio with 2 channels surrounding sound.

All in One multimedia solution

Based on Intel QM77 chipset, the board provides high performance onboard graphics, 24-bit dual channel LVDS interface, DVI and 2 channels High Definition Audio, to meet the very requirement of the multimedia application.

1.2 <Product Specification>

General Specification

Form Factor	PICMG 1.3 Half-size CPU Card
CPU	3 rd Generation Intel® Core™ i7, Core™ i5, Core™ i3 Mobile Processor Package type: rPGA988B
Memory	2 x DDRIII SO-DIMM 1066/1333/1600 MHz up to 16GB Support Non-ECC, unbuffered memory only
Chipset	Intel QM77
Real Time Clock	Chipset integrated RTC with onboard lithium battery
Watchdog Timer	Generates a system reset with internal timer for 1min/s ~255min/s
Power Management	Supports ACPI 3.0 compliant,
DVI Interface	Onboard DVI connector interface
LVDS Interface	Onboard 24-bit dual channel LVDS connector with +3.3V/+5V/+12V supply
Serial ATA Interface	2 x serial ATAI interface with 300MB/s transfer rate 2 x serial ATAIII interface with 600MB/s transfer rate Support RAID 0, 1, 5, 10 and Intel Rapid Storage Technology
Audio Interface	Realtek ALC888 HD Audio
LAN Interface	1 x Intel 82579LM Gigabit LAN (Support iAMT8.0) 1 x Intel 82574L Gigabit LAN
GPIO interface	Onboard programmable 8-bit Digital I/O interface
Extended Interface	PICMG 1.3 Half-size Interface Support 1 PCI-Express x16 · 1 PCI-Express x4 or 4 PCI-Express x1 and 1 x PCIE mini card socket (Optional support mSATA(SATAII) for Mini_Card)
Internal I/O Port	5 x RS232, 1 x RS232/422/485, 1 x SMBUS, 1 x GPIO, 4 x USB3.0 ports, 2 x USB2.0 ports, 1 x IrDA, 1 x DVI, 1 x LVDS, 2 x Serial ATAI, 2 x Serial ATAIII, 1 x Front panel Audio and 1 x CDIN
External I/O Port	1 x VGA Port, 2 x RJ45 and 1 x PS/2 Keyboard/Mouse Port
Power Requirement	+12V , 5VSB & 3VSB from Backplane
Dimension	168mm x 126mm
Temperature	Operating within 0~60 centigrade Storage within -20~85 centigrade

Ordering Code

HS-B701	Intel PGA988B + QM77 Onboard VGA, LVDS, DVI, LAN, USB2.0, USB3.0, HD Audio, SATAII ,SATAIII, SMBUS, LPC, IrDA, GPIO, PCI Express mini card and mSATA Support Four X1 & One X16 PCI Express interface
HS-B704	Intel PGA988B + QM77 Onboard VGA, LVDS, DVI, LAN, USB2.0, USB3.0, HD Audio, SATAII ,SATAIII, SMBUS, LPC, IrDA, GPIO, PCI Express mini card and mSATA Support One X4 & One X16 PCI Express interface

The specifications may be different as the actual production.

For further product information please visit the website at <http://www.commell.com.tw>.

1.3 <Mechanical Drawing>

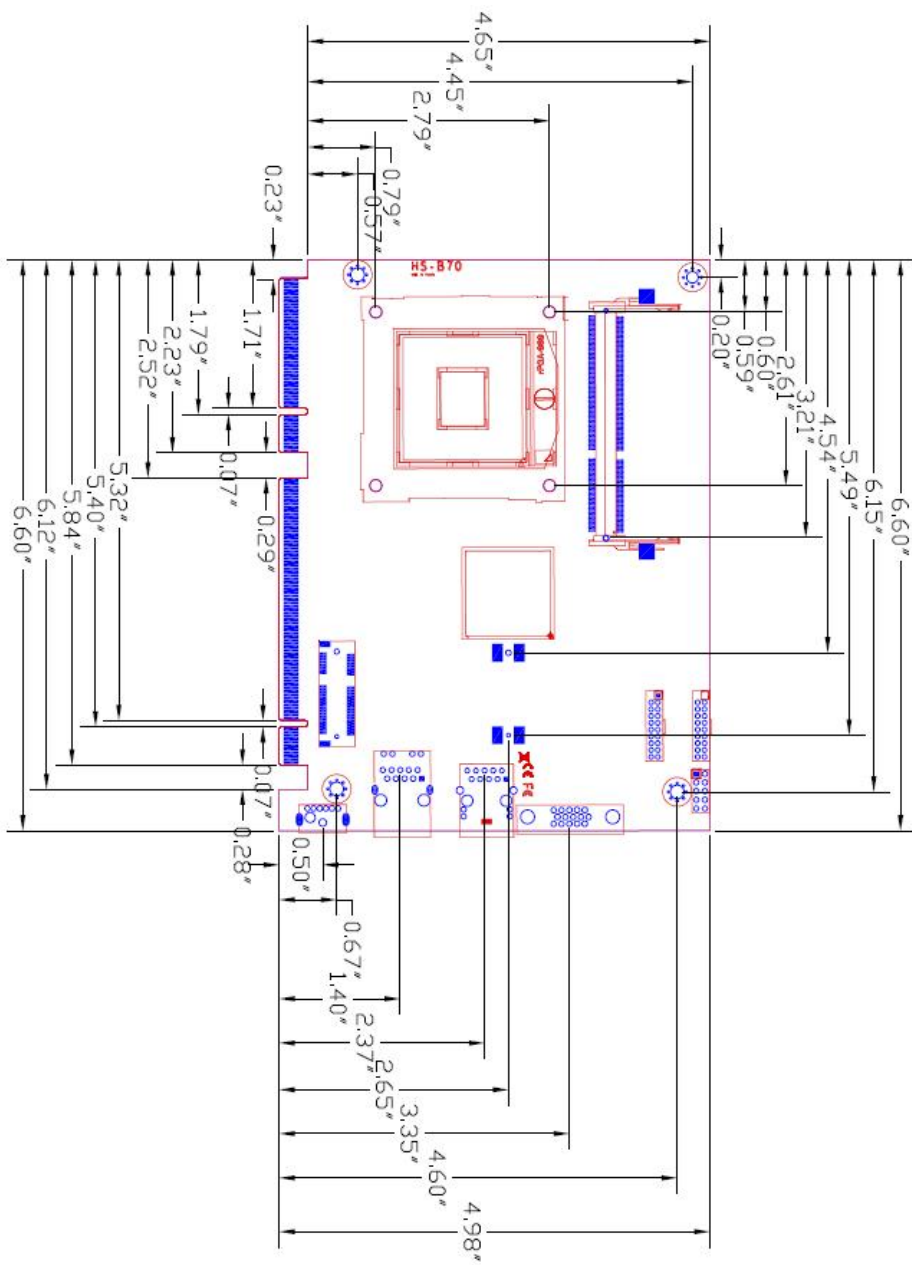

unit: inch

1.4 <Block Diagram>

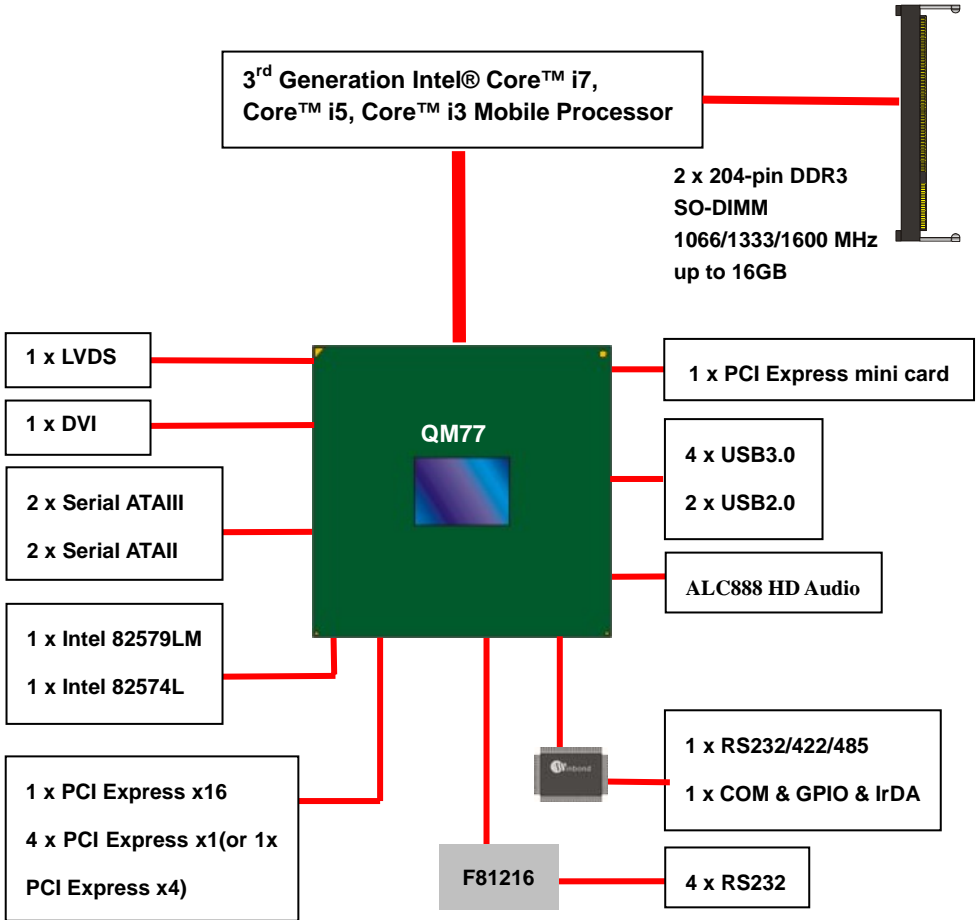

Chapter 2 <Hardware Setup>

2.1 <Connector Location>

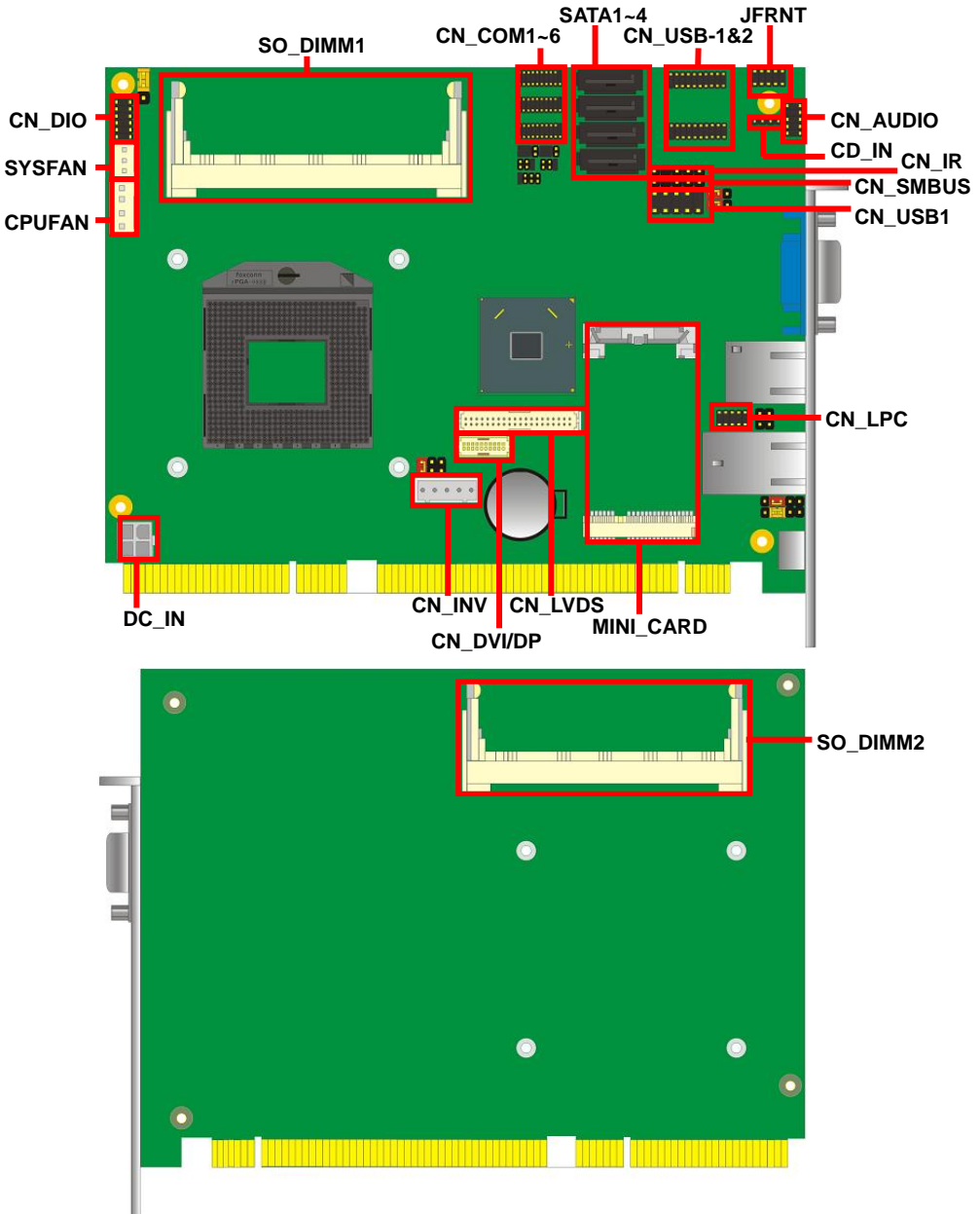

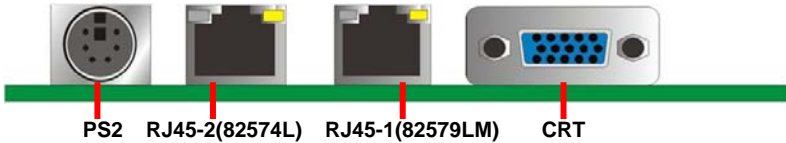

2.2 <Jumper Location & Reference>

Jumper	Function
JRTC	CMOS Operating/Clear Setting
JVLCD	Panel Voltage Setting
JAT	Power mode select
JP1	Com1 Voltage Setting (For Pin 9)
JP2	Com2 Voltage Setting (For Pin 9)
JCSEL1	CN_COM2 RS-232 RS422 RS485 Setting
JCSEL2	CN_IR IrDA Setting
JVUSB	USB Voltage Setting

2.3 <Connector Reference>

2.3.1 <Internal Connectors>

Connector	Function	Remark
CPU	Socket rPGA988B for PGA988 CPU	
SO-DIMM 1/2	204 -pin DDR3 SO-DIMM socket	
SATA 1/2	7-pin Serial ATAIII connector	
SATA 3/4	7-pin Serial ATAI connector	
DC_IN	4-pin power supply connector	
CN_AUDIO	5 x 2-pin audio connector	
CD_IN	4-pin CD-ROM audio input connector	
CN_DIO	6 x 2-pin digital I/O connector	
CN_USB1	5 x 2-pin USB2.0 connector	
CN_USB3- 1/2	10 x 2-pin USB3.0 connector	
CPUFAN	4-pin CPU cooler fan connector	
SYSFAN	4-pin system cooler fan connector	
CN_LVDS	20 x 2-pin LVDS connector	
CN_INV	5-pin LCD inverter connector	
CN_DVI/DP	10 x 2-pin DVI connector	
CN_IR	5-pin IrDA connector	
CN_COM 1/2 ,3/4, 5/6	19-pin RS232 & RS422/485/232 connector	
CN_LPC	5 x 2-pin LPC connector	
JFRNT	10-pin front panel switch/indicator connector	
Mini-PCIE	1 x 52-pin Mini-PCIE socket	
JAT	Power mode select	
JSPD 1/2	LAN Speed LED connector	
JACT 1/2	LAN Activity LED connector	

2.3.2 <External Connectors>

Connector	Function	Remark
CRT	VGA connector	
RJ45_1/2	RJ45 LAN connector	
PS/2	PS/2 keyboard and mouse connector	

2.4 <CPU and Memory Setup>

2.4.1 <CPU Setup>

The board comes with the socket rPGA988 for Intel **Ivy Bridge** Processor, Please follow the instruction to install the CPU properly.

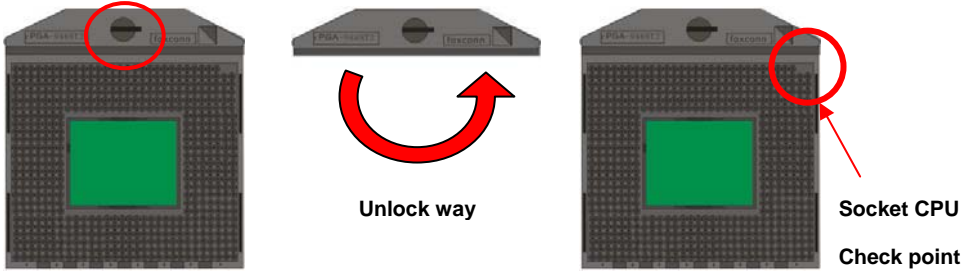

1. Use the flat-type screw drive to unlock the CPU socket

2. Follow the pin direction to install the processor on the socket

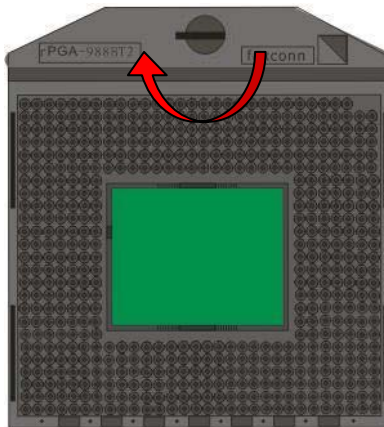

3. Lock the socket

2.4.2 <Memory Setup>

The board provides 2 x 204-pin DDR3 SO-DIMM to support 1066/1333/1600MHz DDR3 memory module up to 16GB.

Support Non-ECC, unbuffered memory only.

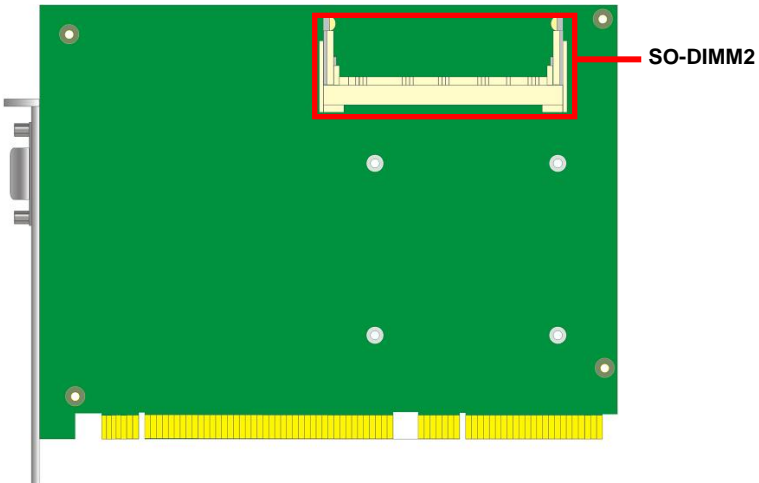
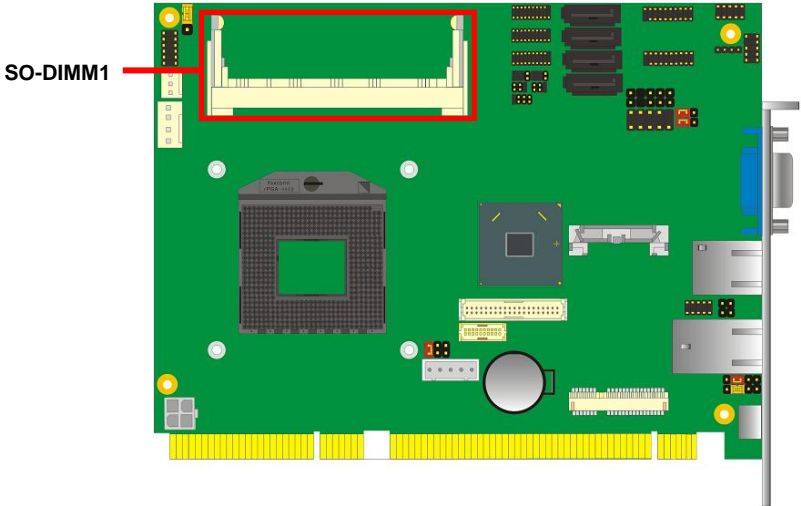

2.5 <CMOS & ATX Setup>

The board's data of CMOS can be setting in BIOS. If the board refuses to boot due to inappropriate CMOS settings, here is how to proceed to clear (reset) the CMOS to its default values.

Jumper: JRTC

Type: Onboard 3-pin jumper

JRTC	Mode
1-2	Clear CMOS
2-3	Normal Operation

Default setting: 2-3

Jumper: JAT

Type: onboard 3-pin jumper

JAT	Mode
1-2	AT Mode
2-3	ATX Mode

Default setting:2-3

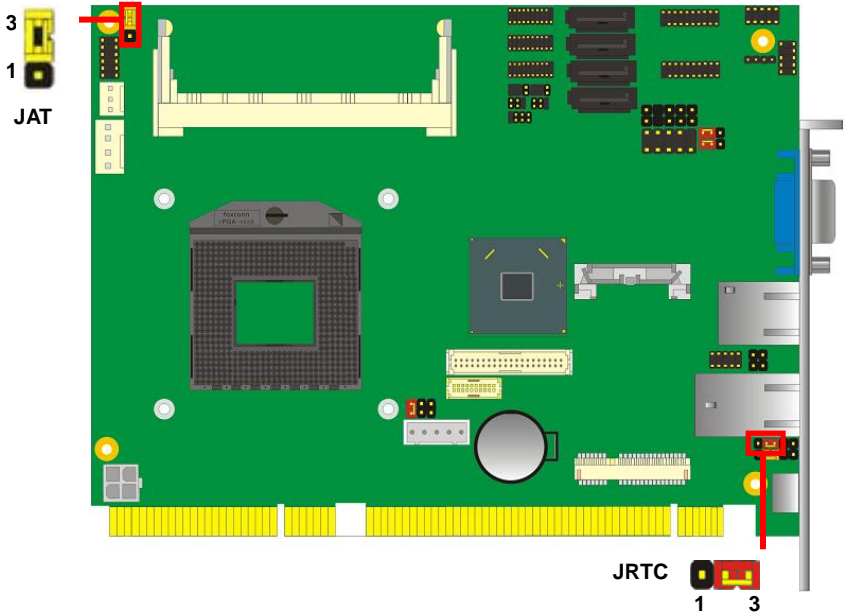

2.6 <Serial ATA Interface>

HS-B70 has Two Serial ATA II(SATA Port3/4) & Two Serial ATA III(SATA Port1/2) interfaces with RAID function, the transfer rate of the Serial ATA II can be up to 300MB/s & Serial ATA III can be up to 600MB/s. Please go to <http://www.serialata.org/> for more about Serial ATA technology information. Based on Intel® PCH, it supports Intel® **Matrix Storage Technology** with combination of RAID 0,1,5 and 10. The main features of RAID on Intel® QM77 PCH are listed below:

1. Supports for up to RAID volumes on a single, two-hard drive RAID array.
2. Supports for two, two-hard drive RAID arrays on any of six Serial ATA ports.
3. Supports for Serial ATA ATAPI devices.
4. Supports for RAID spares and automatic rebuild.
5. Supports on RAID arrays, including NCQ and native hot plug.

For more information please visit Intel's official website.

For more about the system setup for Serial ATA, please check the chapter of SATA configuration.

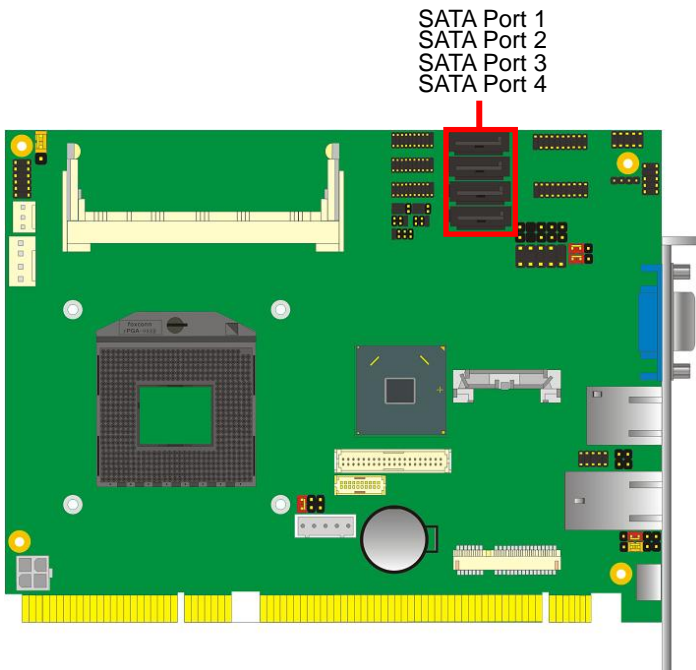

2.7 <Ethernet Interface>

The board integrates with one Intel 82574L Gigabit Ethernet & one Intel 82579LM controllers, as the PCI Express bus. The Intel 82574L & 82579LM supports triple speed of 10/100/1000Base-T, with IEEE802.3 compliance and Wake-On-LAN supported.

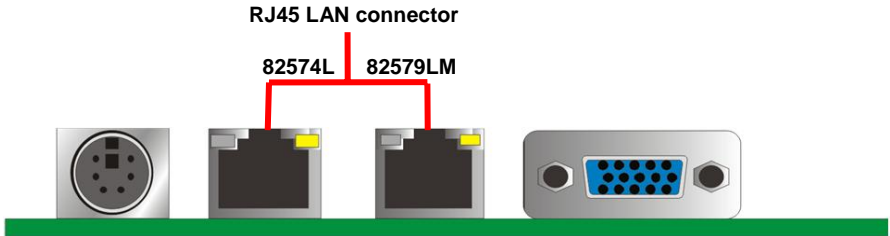

Onboard Intel® 82579LM GbE controller support Intel® AMT 8.0 feature on primary LAN port. The BIOS is ready to support Intel® AMT 8.0 feature. The necessary prerequisite is your CPU must support Intel® vPro technology, ex. [i7-3610QE](#)

For further instruction about the Intel® AMT features and set up, please refer to the [iAMT Setting.pdf](#).

2.8 <Onboard Display Interface>

Based on Intel **Ivy Bridge** CPU with built-in HD Graphic, the board provides one DB15 connector on rear external I/O port, one 40-pin LVDS interface with 5-pin LCD backlight inverter connector and provides 20-pin DVI interface.

The board provides dual display function with clone mode and extended desktop mode for CRT, LCD and DVI.

2.8.1 <Analog Display>

Please connect your CRT or LCD monitor with DB15 male connector to the onboard DB15 female connector on rear I/O port.

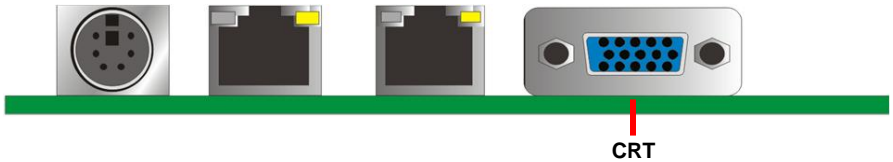

2.8.2 <Digital Display>

The board provides one 40-pin LVDS connector for 24-bit single/dual channel panels, supports up to 2048 x 1536 (UXGA) resolution, with one LCD backlight inverter connector and one jumper for panel voltage setting.

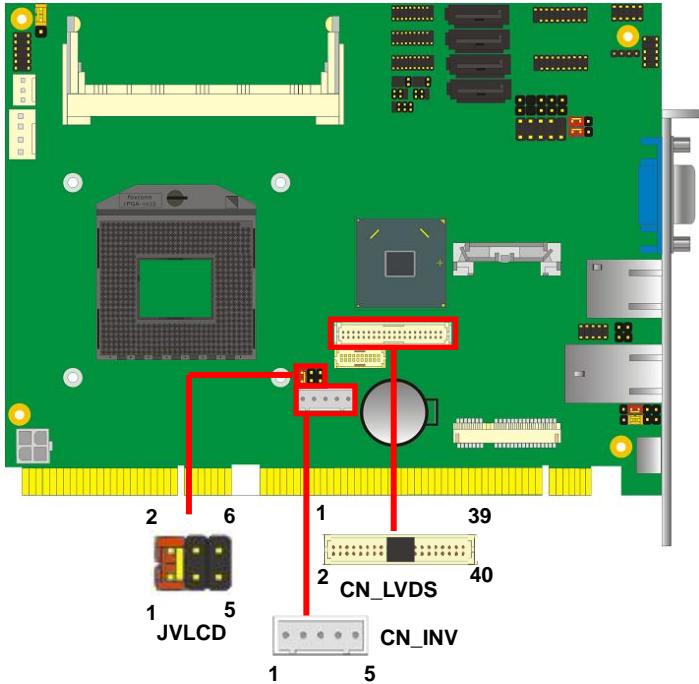

Effective patterns of connection: 1-2 / 3-4 / 5-6



Warning: others cause damages

Connector: **CN_INV**

Type: 5-pin LVDS Power Header

Pin	Description
1	+12V
2	Reserved (Note)
3	GND
4	GND
5	ENABKL

Note: Reserved for MB internal test
Please treat it as NC.

Connector: **JVLCD**

Type: 6-pin Power select Header

Pin	Description
1-2	LCDVCC (3.3V)
3-4	LCDVCC (5V)
5-6	LCDVCC (12V)

Default: 1-2

Connector: **CN_LVDS**

Type: onboard 40-pin connector for LVDS connector

Connector model:

E&T 3950-B40C-00R or similar (**HIROSE DF13-40DP-1.25V** compatible)

Pin	Signal	Pin	Signal
2	LCDVCC	1	LCDVCC
4	GND	3	GND
6	ATX0-	5	BTX0-
8	ATX0+	7	BTX0+
10	GND	9	GND
12	ATX1-	11	BTX1-
14	ATX1+	13	BTX1+
16	GND	15	GND
18	ATX2-	17	BTX2-
20	ATX2+	19	BTX2+
22	GND	21	GND
24	ACLK-	23	BTX3-
26	ACLK+	25	BTX3+
28	GND	27	GND
30	ATX3-	29	BCLK-
32	ATX3+	31	BCLK+
34	GND	33	GND
36	DDCPCLK	35	SMBCKL
38	DDCPDATA	37	SMBDATA
40	N/C	39	SPDIFO

HS-B70 User's Manual

To setup the LCD, you need the component below:

1. A panel with LVDS interfaces.
2. An inverter for panel's backlight power.
3. A LCD cable and an inverter cable.

For the cables, please follow the pin assignment of the connector to make a cable, because every panel has its own pin assignment, so we do not provide a standard cable; please find a local cable manufacture to make cables.

LCD Installation Guide:

1. Preparing the **HS-B70**, **LCD panel** and the **backlight inverter**.

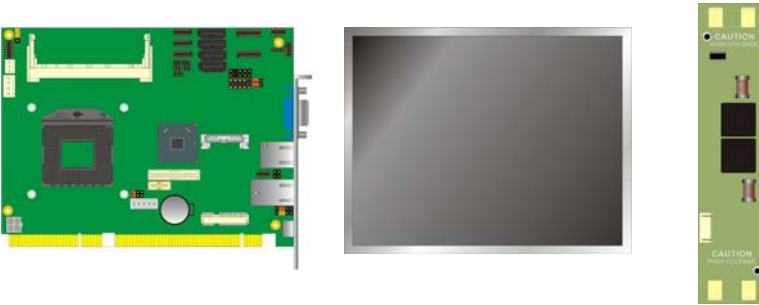

2. Please check the datasheet of the panel to see the voltage of the panel, and set the jumper **JVLCD** to +12V or +5V or +3.3V.
3. You would need a LVDS type cable.

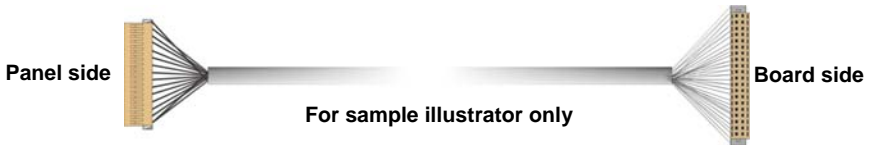

4. To connect all of the devices well.

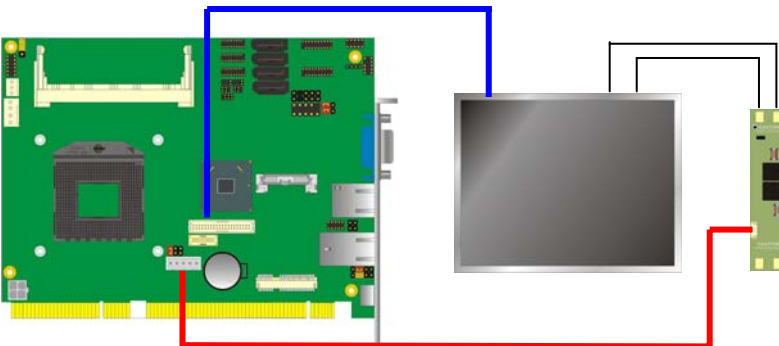

After setup the devices well, you need to select the LCD panel type in the BIOS.

The panel type mapping is list below:

BIOS panel type selection form (BIOS Version:1.0)			
Single / Dual channel		Single / Dual channel	
NO.	Output format	NO.	Output format
1	640 x 480	9	1680 x 1050
2	800 x 600	10	1920 x 1200
3	1024 x 768	11	1440 x 900
4	1280 x 1024	12	1600 x 900
5	1400 x 1050 Reduced Blanking	13	800 x 480
6	1400 x 1050 non-Reduced Blanking	14	1280 x 800
7	1680 x 1200	15	1920 x 1080
8	1366 x 768	16	OEM Keep

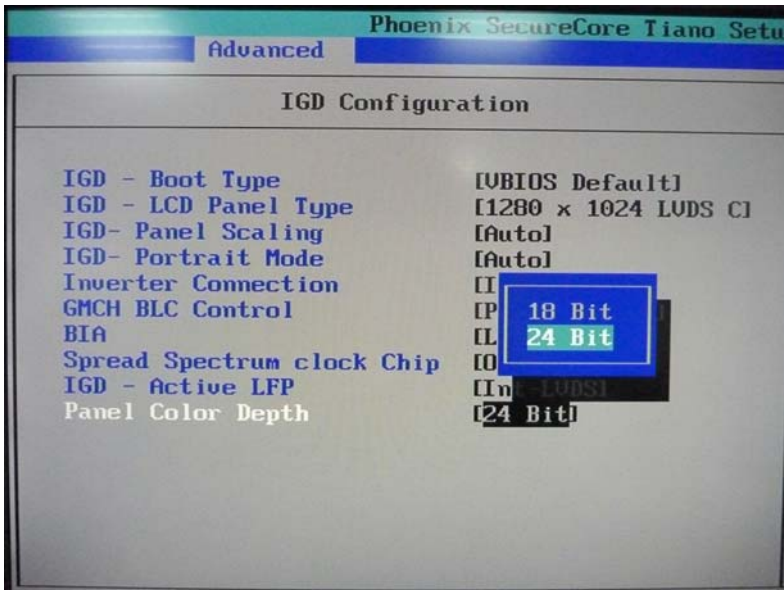

2.8.3 <DVI Interface>

Connector: **CN_DVI**

Connector type:

E&T 3950-B20C-00R or similar (HIROSE DF13-20DP-1.25V compatible)

Pin Number	Assignment	Pin Number	Assignment
1	+5V	2	+3.3V
3	HPD	4	Ground
5	TMDSTX0N	6	TMDSTX0P
7	Ground	8	TMDSTX1N
9	TMDSTX1P	10	Ground
11	TMDSTX2N	12	TMDSTX2P
13	Ground	14	TMDSTXCEN
15	TMDSTXCP	16	Ground
17	DVI_DA	18	DVI_SL
19	AUXN	20	AUXP

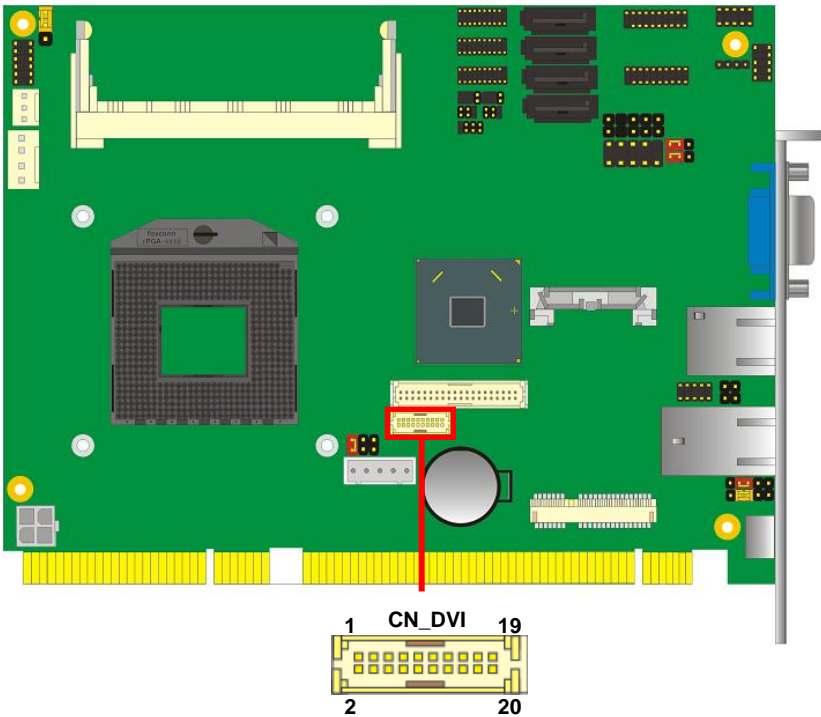

2.9 <Integrated Audio Interface>

The board provides the onboard high definition audio with Realtek ALC888.

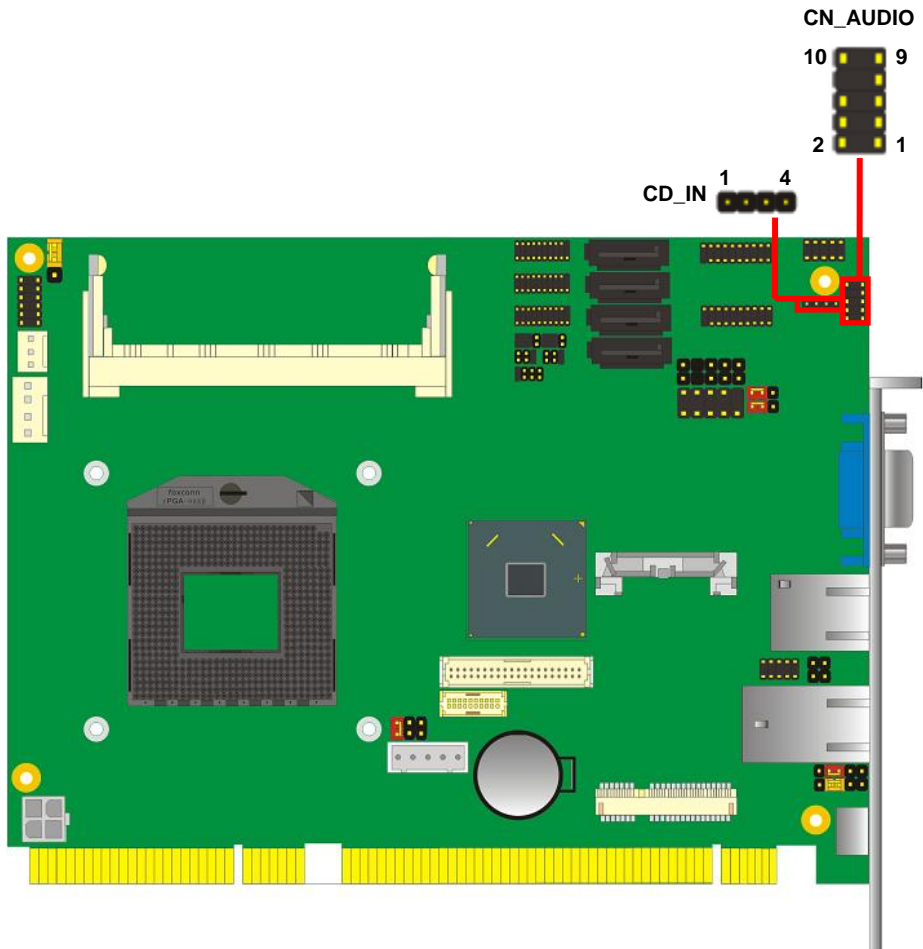

Connector: CN_AUDIO

Type: 10-pin (2 x 5) header (pitch = 2.54mm)

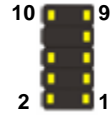

Pin	Description	Pin	Description
1	MIC_L	2	Ground
3	MIC_R	4	N/C
5	Speaker_R	6	MIC Detect
7	SENSE	8	N/C
9	Speaker_L	10	Speaker Detect

Connector: CDIN

Type: 4-pin header (pitch = 2.54mm)



Pin	Description
1	CD – Left
2	Ground
3	Ground
4	CD – Right

2.10 <USB Interface>

HS-B70 integrates four USB3.0 ports and two USB2.0 ports.

The specifications of USB3.0 are listed below:

Interface	USB3.0
Controller	Intel®QM77
Transfer Rate	Up to 5Gb/s
Voltage	5V

The specifications of USB2.0 are list:

Interface	USB2.0
Controller	Intel®QM77
Transfer Rate	Up to 480Mb/s
Voltage	5V

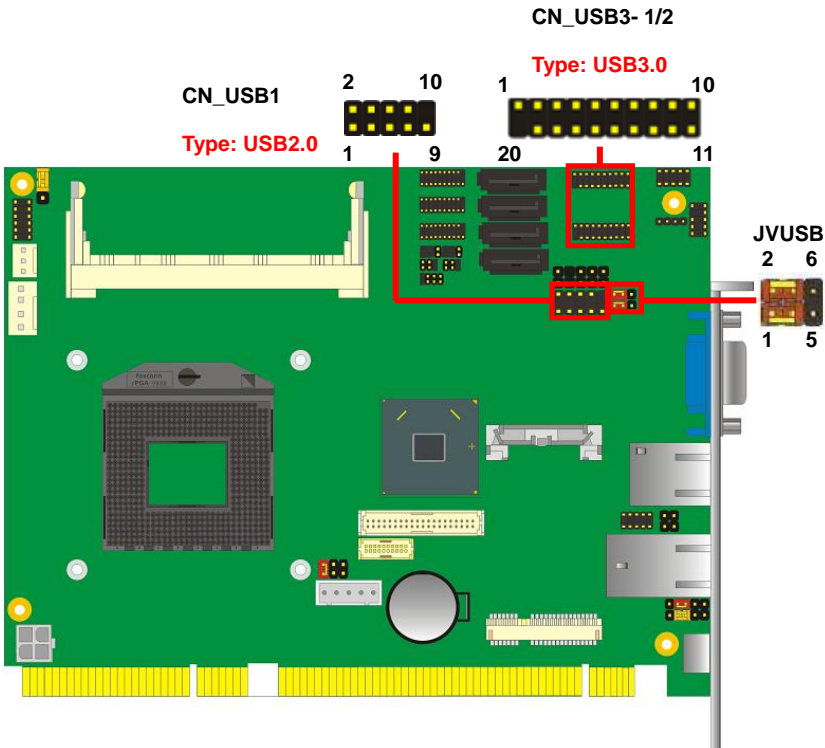

Connector: **CN_USB3- 1/2**

Type: 20-pin (2 x 10) header (pitch = 2.0mm)

Pin	Description	Pin	Description
1	VCC(5V_SB/ 5V)	20	NC
2	USB3.0_RX0-	19	VCC(5V_SB/ 5V)
3	USB3.0_RX0+	18	USB3.0_RX1-
4	Ground	17	USB3.0_RX1+
5	USB3.0_TX0-	16	Ground
6	USB3.0_TX0+	15	USB3.0_TX1-
7	Ground	14	USB3.0_TX1+
8	Data0-	13	Ground
9	Data0+	12	Data1-
10	NC	11	Data1+

Connector: **CN_USB1**

Type: 10-pin (2 x 5) header (pitch = 2.54mm)

Pin	Description	Pin	Description
1	VCC (5V_SB/ 5V)	2	VCC (5V_SB/ 5V)
3	Data0-	4	Data1-
5	Data0+	6	Data1+
7	Ground	8	Ground
9	Ground	10	N/C

Connector: **JVUSB**

Type: 6-pin Power select jumper

Pin	Description
1-3 & 2-4	5V_SB
3-5 & 4-6	5V

Default: 1-3 & 2-4

Effective patterns of connection: 1-3 & 2-4 or 3-5 & 4-6

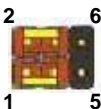

Warning: others cause damages

2.11 <Serial Port>

The board supports five RS232 serial port and one jumper selectable RS232/ 422/485 serial ports. The jumper JCSEL1 and JCSEL2 can let you configure the communicating modes for COM2.





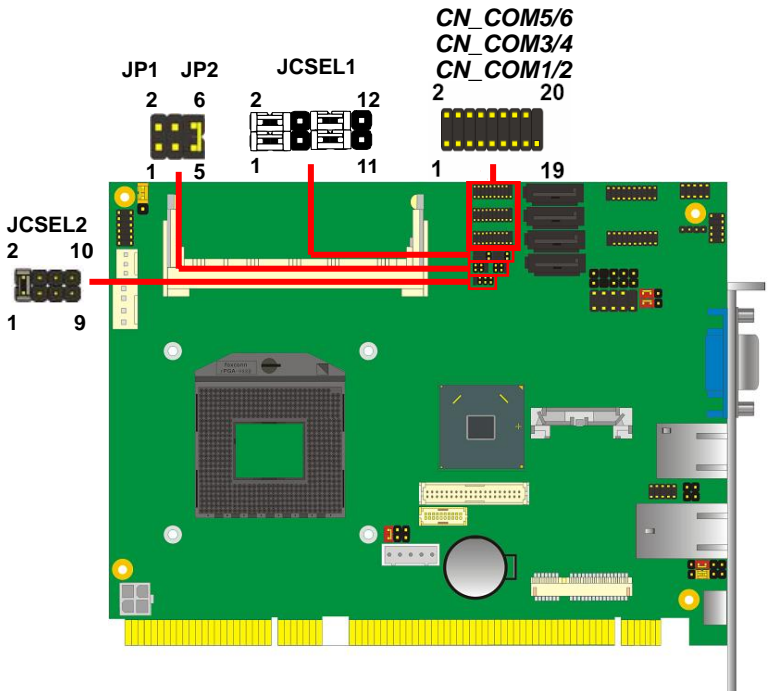

Connector: **COM 1/2, 3/4, 5/6**

Type: 20-pin (2 x 10) header pitch = 2.54x1.27mm

Pin	Description	Pin	Description
1	DCD1	2	RXD1
3	TXD1	4	DTR1
5	GND1	6	DSR1
7	RTS1	8	CTS1
9	RI1	10	N/C
11	DCD2/422TX-/485-	12	RX2/422TX+/485+
13	TX2/422RX+	14	DTR2/422RX-
15	Ground	16	DSR2
17	RTS2	18	CTS2
19	RI2	20	N/C

Setting RS-232 & RS-422 & RS-485 for COM2

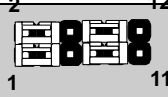

Function	JCSEL2	JCSEL1
IrDA		
RS-422		
RS-485		
RS-232		

Default setting:

JCSEL1: (1-3, 2-4, 7-9, 8-10) JCSEL2: (1-2)

Jumper: **JP1/JP2 (COM1/2)**

Type: onboard 6-pin header

Power Mode	JP1/2/3/4
Pin 9 with 5V Power	1-2
Pin 9 with 12V Power	3-4
Standard COM port	5-6

Default setting: 5-6

2.12 <PCIe Mini Card >

The board provides one PCIe mini card sockets.

MINI_CARD slot and option support mSATA.

MINI_CARD is the first Mini-PCIe slot for long size Mini-PCIe cards.

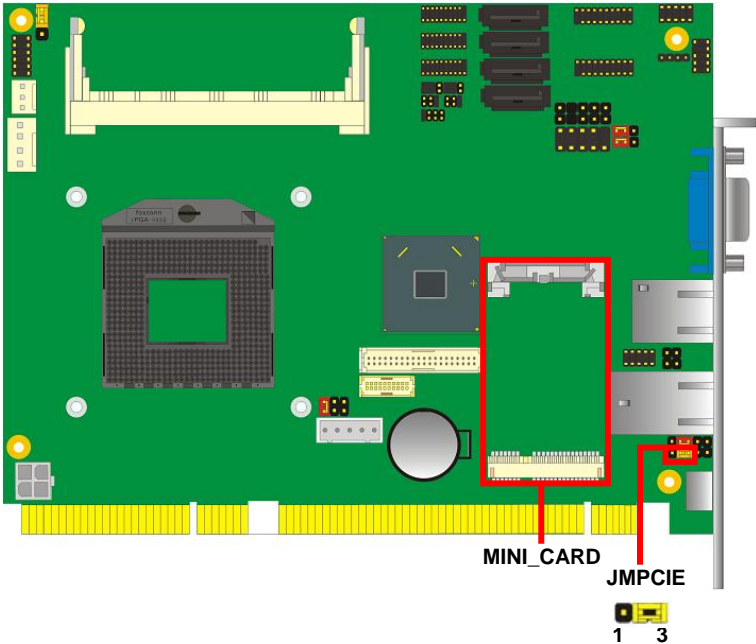

Jumper: **JMPCIE**
Type: onboard 3-pin header

MINI_CARD Mode	JMPCIE
Supply mSATA	1-2
MINI_CARD	2-3

Default setting: 2-3

2.13 <GPIO and SMBUS Interface>

The board provides a programmable 8-bit digital I/O interface; you can use this general purpose I/O port for system control like POS or KIOSK.

Connector: **CN_DIO**

Type: 12-pin (6 x 2) header (pitch = 2.0mm)

Pin	Description	Pin	Description
1	Ground	2	Ground
3	GP10	4	GP14
5	GP11	6	GP15
7	GP12	8	GP16
9	GP13	10	GP17
11	5V	12	12V

Connector: **CN_SMBUS**

Type: 5-pin header for SMBUS Ports

Pin	Description
1	VCC
2	N/C
3	SMBDATA
4	SMBCLK
5	Ground

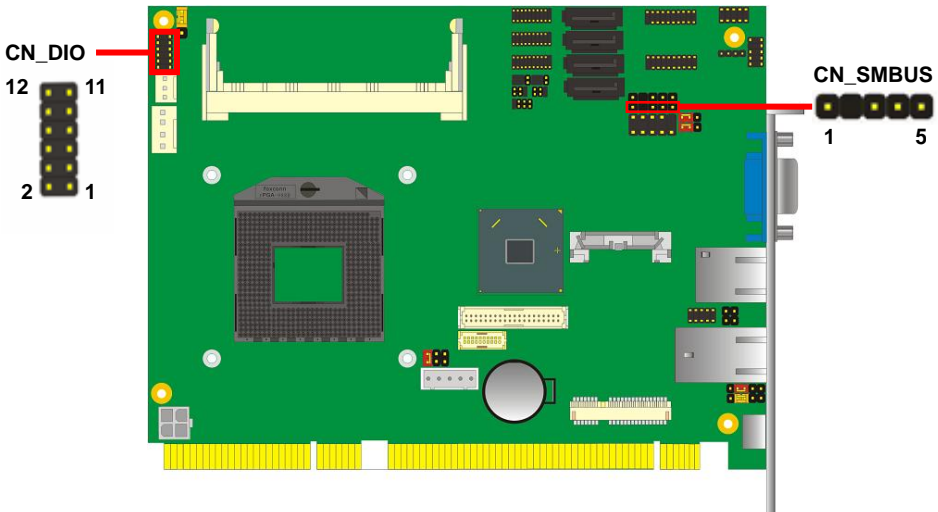

2.14 <Power Supply and Fan Interface >

The HS-B70 needs a standard ATX power supply from Backplane's +12V , 5VSB & 3VSB and the board provides one 4-pin fan connector supporting smart fan for CPU cooler and one 4-pin cooler fan connectors for system and Northbridge chip. please connect this well before you finishing the system setup.

2.14.1 <Power Input>(need Backplane)

Connector: DC_IN

Type: 4-pin header

Pin	Description	Pin	Description
1	Ground	3	+12V
2	Ground	4	+12V

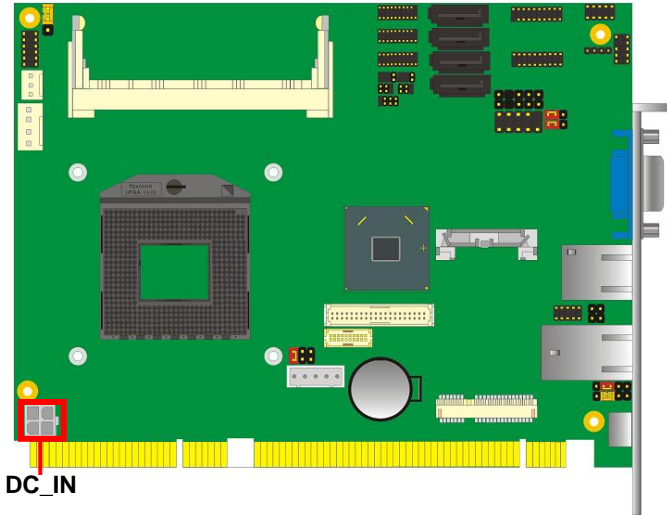

2.14.2 <Fan connector>

The board provides one **4-pin** fan connectors supporting smart fan for CPU cooler and one **3-pin** cooler fan connectors for system.

Connector: **CPUFAN**

Type: 4-pin fan wafer connector

Pin	Description	Pin	Description
1	Ground	2	+12V
3	Fan Speed Detection	4	Fan Control

Connector: **SYSFAN**

Type: 3-pin fan wafer connector

Pin	Description	Pin	Description	Pin	Description
1	Ground	2	+12V	3	Sense

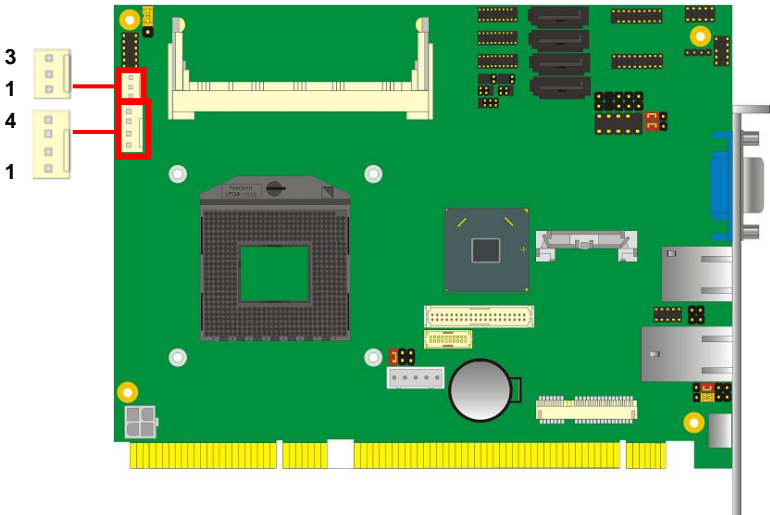

2.15 <Switch and Indicator>

The **JFRNT** provides front control panel of the board, such as power button, reset and beeper, etc. Please check well before you connecting the cables on the chassis.

Connector: **JFRNT**

Type: onboard 10-pin (2 x 5) 2.54-pitch header

Function	Signal	PIN		Signal
Power	PWRBT-	1	2	PWRBT+
Speaker	SPK-	3	4	SPK+
HDD LED	HLED-	5	6	HLED+
Power LED	PWRLED-	7	8	PWRLED+
Reset	Reset+	9	10	Reset-

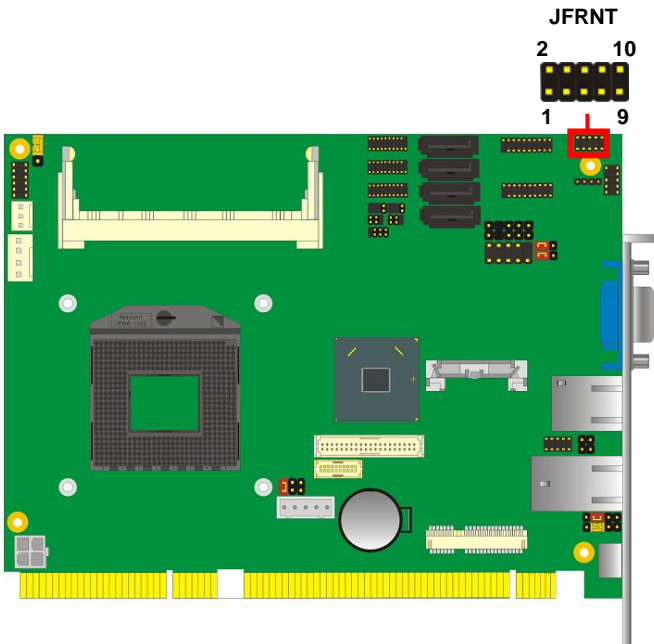

Chapter 3 <System Setup>

3.1 <Audio Configuration>

The board integrates Intel® QM77 with REALTEK® ALC888 codec. It can support 2-channel sound under system configuration. Please follow the steps below to setup your sound system.

1. Install REALTEK HD Audio driver.
2. Lunch the control panel and Sound Effect Manager.

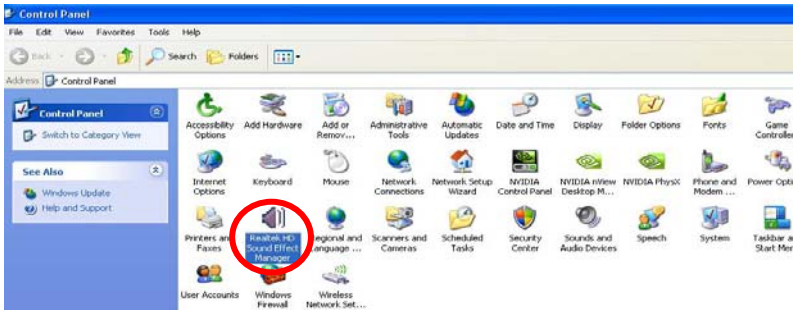

3. Select Speaker Configuration



3.2 <Display Properties Setting>

Based on Intel QM77 with HD Graphic, the board supports two DACs for display device as different resolution and color bit.

Please install the Intel Graphic Driver before you starting setup display devices.

1. Click right button on the desktop to lunch **display properties**

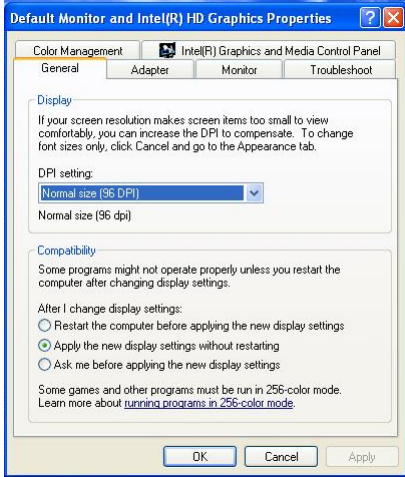

2. Click **Advanced** button for more specificity setup.

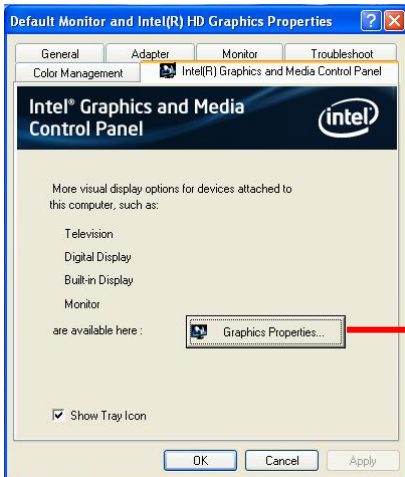

Click Graphics Properties... for advanced setup

3. This setup options can let you define each device settings.

Click **Monitor** to setup the CRT monitor for Resolution and Refresh Rate

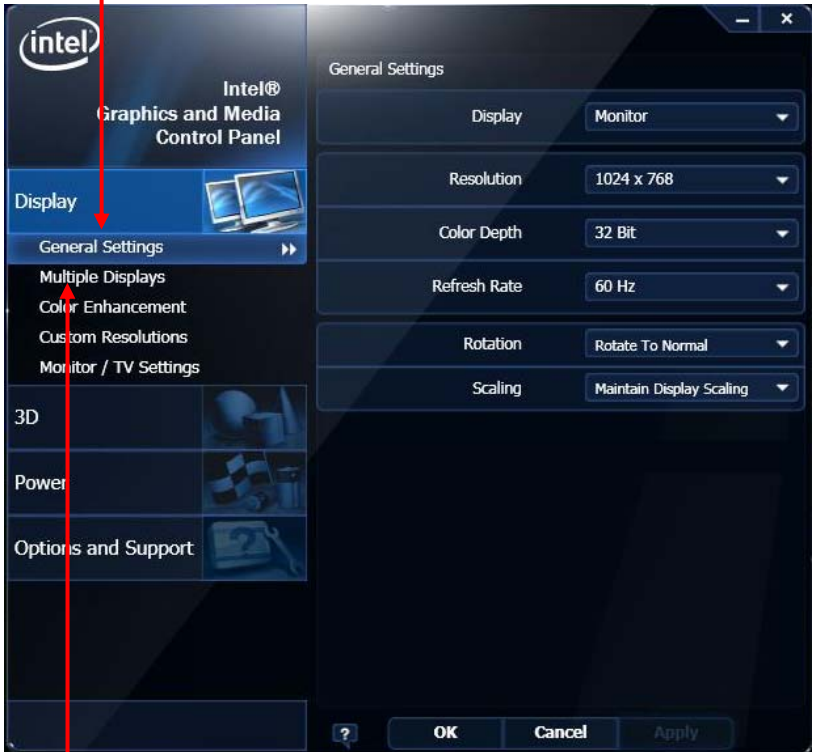

Click **Intel® Dual Display Clone** to setup the dual display mode as same screen

3.3 <SATA configuration>

SATA Mode:

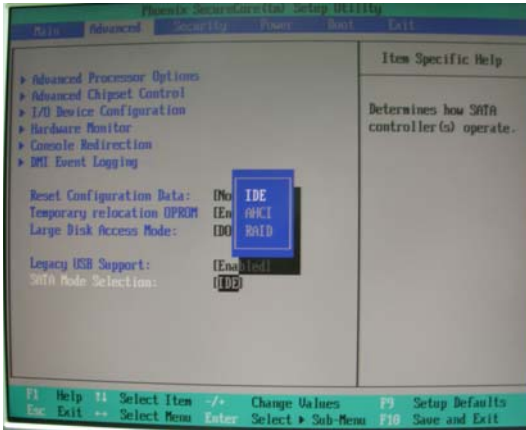

This option can let you select whether the Serial ATA hard drives would work under normal IDE mode or RAID mode. The RAID mode need more than one HDD is applied.

3.4 <SATA RAID Configuration>

The board integrates Intel® QM77 PCH with RAID function for Serial ATA drives, and supports the configurations below:

RAID 0 (Striping): Two hard drives operating as one drive for optimized data R/W performance. It needs two unused drives to build this operation.

RAID 1 (Mirroring): Copies the data from first drive to second drive for data security, and if one drive fails, the system would access the applications to the workable drive. It needs two unused drives or one used and one unused drive to build this operation. The second drive must be the same or larger size than first one.

RAID 5 (striping with parity)

A RAID 5 array contains three or more hard drives where the data is divided into manageable blocks called strips. Parity is a mathematical method for recreating data that was lost from a single drive, which increases fault-tolerance. The data and parity are striped across all the hard drives in the array. The parity is striped in a rotating sequence to reduce bottlenecks associated with the parity calculations.

RAID 10 (RAID 0+1)

A RAID 10 array uses four hard drives to create a combination of RAID levels 0 and 1. The data is striped across a two-drive array forming the RAID 0 component. Each of the drives in the RAID 0 array is then mirrored by a RAID 1 component.

Intel Matrix Storage Technology: This technology would allow you to use **RAID 0+1** mode on only two drives (4 drives needed on traditional RAID 0+1). It will create two partitions on each hard drive to simulate **RAID 0** and **RAID 1**. It also can let you modify the partition size without re-formatted.

For more information of Intel Matrix Storage Technology, please visit Intel's website.

If you need to install an operation system on the RAID set, please use the driver disk attached in the package when it informs you to obtain the RAID drivers.

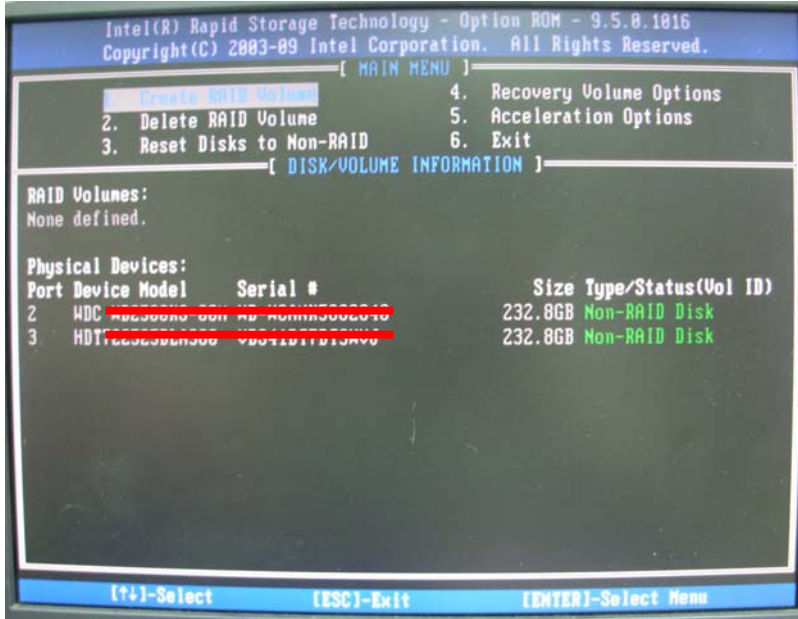

Please press <CTRL+I> to enter the RAID configuration menu.

You can setup the RAID under operation system for Microsoft® Windows XP SP1 , please install the Intel® Application Accelerator Ver.4.5 later to support RAID configuration with Intel® Matrix Storage Technology

Chapter 4 <BIOS Setup>

The motherboard uses the Phoenix BIOS for the system configuration. The Phoenix BIOS in the single board computer is a customized version of the industrial standard BIOS for IBM PC AT-compatible computers. It supports Intel x86 and compatible CPU architecture based processors and computers. The BIOS provides critical low-level support for the system central processing, memory and I/O sub-systems.

The BIOS setup program of the single board computer let the customers modify the basic configuration setting. The settings are stored in a dedicated battery-backed memory, NVRAM, retains the information when the power is turned off. If the battery runs out of the power, then the settings of BIOS will come back to the default setting.

The BIOS section of the manual is subject to change without notice and is provided here for reference purpose only. The settings and configurations of the BIOS are current at the time of print, and therefore they may not be exactly the same as that displayed on your screen.

To activate CMOS Setup program, press key immediately after you turn on the system. The following message "Press DEL to enter SETUP" should appear in the lower left hand corner of your screen. When you enter the CMOS Setup Utility, the Main Menu will be displayed as **Figure 4-1**. You can use arrow keys to select your function, press <Enter> key to accept the selection and enter the sub-menu.

Figure 4-1 CMOS Setup Utility Main Screen

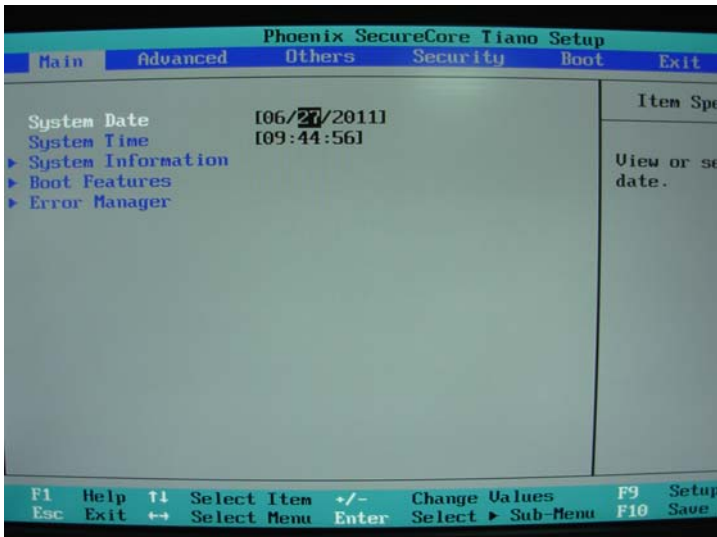

(This page is left for blank)

Appendix A <I/O Port Pin Assignment>

A.1 <Serial ATA Port>

Connector: **SATA1/2/3/4**

Type: 7-pin wafer connector

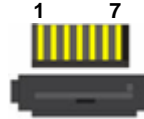

1	2	3	4	5	6	7
GND	RSATA_TXP1	RSATA_TXN1	GND	RSATA_RXN1	RSATA_RXP1	GND

A.2 <IrDA Port>

Connector: **CN_IR**

Type: 5-pin header for SIR Ports

JCSEL1 must jump to "SIR"

Pin	Description
1	VCC
2	N/C
3	IRRX
4	Ground
5	IRTX



A.3 <VGA Port>

Connector: **CRT**

Type: 15-pin D-sub female connector on bracket

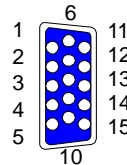

Pin	Description	Pin	Description	Pin	Description
1	RED	6	Ground	11	N/C
2	GREEN	7	Ground	12	DDCDA
3	BLUE	8	Ground	13	HSYNC
4	N/C	9	N/C	14	VSYNC
5	Ground	10	Ground	15	DDCCLK

A.4 <LAN Port>

Connector: **RJ45**

Type: RJ45 connector with LED on bracket

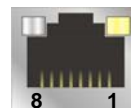

Pin	1	2	3	4	5	6	7	8
Description	MI0+	MI0-	MI1+	MI2+	MI2-	MI1-	MI3+	MI3-

A.5 <LAN LED Port>

Connector: **JSPD1/2**

Type: 5-pin header for LAN Speed LED connector

When Lan speed 10/100Mbps

Pin	Description
1	LED-
2	LED+

When Lan speed 1Gbps

Pin	Description
1	LED+
2	LED-

Connector: **JACT1/2**

Type: 5-pin header for LAN Activity LED connector

Pin	Description
1	LED-
2	LED+

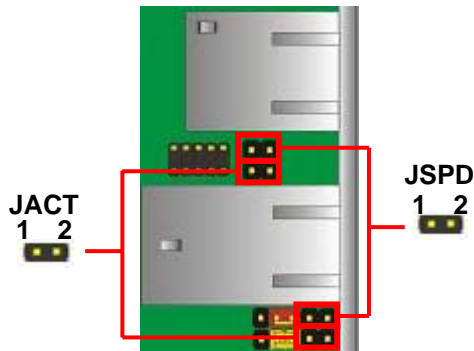

Appendix B <Flash BIOS>

B.1 <Flash Tool>

The board is based on Phoenix BIOS and can be updated easily by the BIOS auto flash tool. You can download the tool online at the address below:

<http://www.phoenix.com/en/home/>

http://www.commell.com.tw/Support/Support_SBC.htm

File name of the tool is "FPT.exe", it's the utility that can write the data into the BIOS flash ship and update the BIOS.

B.2 <Flash BIOS Procedure>

1. Please make a bootable floppy disk.
2. Get the last .bin files you want to update and copy it into the disk.
3. Copy FPT.exe to the disk.
4. Power on the system and flash the BIOS.
(Example: C:/FPT -savemac -f XXX.bin)
5. Restart the system.

Any question about the BIOS re-flash please contact your distributors or visit the web-site at below:

<http://www.commell.com.tw/support/support.htm>

Appendix C <Programming GPIO's >

The GPIO can be programmed with the MSDOS debug program using simple IN/OUT commands. The following lines show an example how to do this.

```
GPIO0.....GPIO7  bit0.....bit7
-o 2 E 87          ;enter configuration
-o 2 E 87
-o 2 E 07
-o 2 F 09          ;enable GPIO function
-o 2 E 30
-o 2 F 02          ;enable GPIO configuration
-o 2 E F0
-o 2 F xx          ;set GPIO as input/output; set '1' for input,'0'for
output
-o 2 E F1
-o 2 F xx          ;if set GPIO's as output, in this register its value can
be set
```

Optional :

```
-o 2 E F2
-o 2 F xx          ; Data inversion register ; '1' inverts the current value
of the bits , '0' leaves them as they are
-o 2 E 30
-o 2 F 01          ; active GPIO's
```

For further information, please refer to Winbond W83627DHG-P datasheet.

Appendix D <Programming Watchdog Timer >

The watchdog timer makes the system auto-reset while it stops to work for a period.

The integrated watchdog timer can be setup as system reset mode by program.

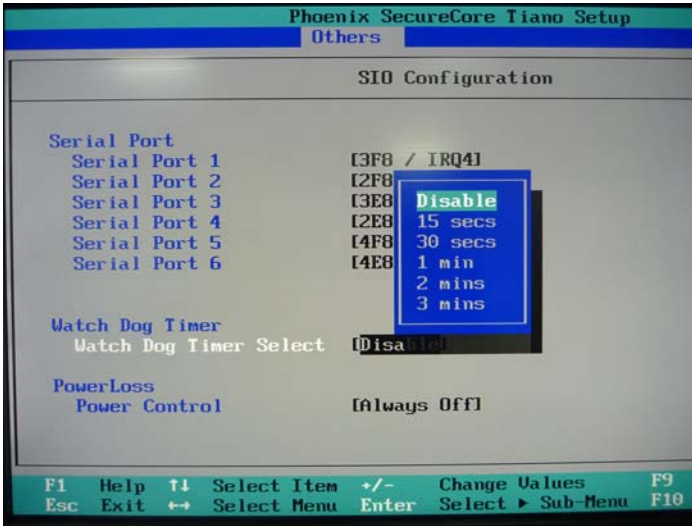

Timeout Value Range

- 1 to 255
- Second or Minute

Program Sample

Watchdog timer setup as system reset with 5 second of timeout

```

2E, 87
2E, 87
2E, 07
2F, 08      Logical Device 8
2E, 30      Activate
2F, 01
2E, F5      Set as Second*
2F, 00
2E, F6      Set as 5
2F, 05
    
```

* Minute: bit 3 = 1; Second: bit 3 = 0

You can select Timer setting in the BIOS, after setting the time options, the system will reset according to the period of your selection.

Contact Information

Any advice or comment about our products and service, or anything we can help you please don't hesitate to contact with us. We will do our best to support you for your products, projects and business.

Taiwan Commate Computer Inc.

Address	19F., No.94, Sec. 1, Xintai 5th Rd., Xizhi Dist., New Taipei City 22102, Taiwan
TEL	+886-2-26963909
FAX	+886-2-26963911
Website	http://www.commell.com.tw
E-Mail	info@commell.com.tw (General Information) tech@commell.com.tw (Technical Support)
Facebook	https://www.facebook.com/pages/Taiwan-Commate-Computer-Inc/547993955271899
Twitter	https://twitter.com/Taiwan_Commamate

Commell is a brand name of Taiwan commate computer Inc.